

FORM 8901
MARCH, 1923

LIST
OF
PARTS



From the library of: Diamond Needle Corp

MACHINES
Nos. 43-1 to 43-6

THE SINGER MANUFACTURING COMPANY

COPYRIGHT, U. S. A.,
1918, 1920, 1922 AND 1923,
BY
THE SINGER MANUFACTURING COMPANY
ALL RIGHTS RESERVED FOR ALL COUNTRIES

INDEX

| | PAGE |
|------------------------------|------|
| ACCESSORIES..... | 39 |
| BINDER..... | 38 |
| BOBBIN WINDERS..... | 39 |
| IRON BASE..... | 39 |
| KNEE LIFTER PARTS..... | 43 |
| MACHINE No. 43-1..... | 7 |
| " " 43-2..... | 13 |
| " " 43-3..... | 18 |
| " " 43-4..... | 23 |
| " " 43-5..... | 28 |
| " " 43-6..... | 33 |
| NUMERICAL LIST OF PARTS..... | 47 |
| OBSOLETE PARTS..... | 46 |
| STAND..... | 45 |

From the library of: Diamond Needle Corp

INSTRUCTIONS FOR ORDERING

In ordering from this list, use **ONLY** the **PART** number in the **FIRST** column.

The number stamped on a Sewing Machine part is in every case the number of the single part only.

Every combination of parts sent out as such has its specific number, which, although not stamped on the parts, must be used when ordering the combination.

Each number always indicates the **SAME PART** in whatever list it appears, or for whatever machine.

The letters after some of the numbers indicate the style of finish only, as follows:

- A. Hardened, Polished and Plated.
- B. Polished and Plated.
- C. Hardened only.
- D. Polished only.
- E. Soft, not Polished.
- F. Hardened and Polished.
- G.
- H. Blued.
- J. Plated only.
- K. Hardened and Plated.
- L. Brass or Gilt
- M. Oxidized.
- P. Japanned.
- R. Parkerized.

These letters **MUST BE USED** when they appear in the list, and **AFTER** the number as in the list.

In this series

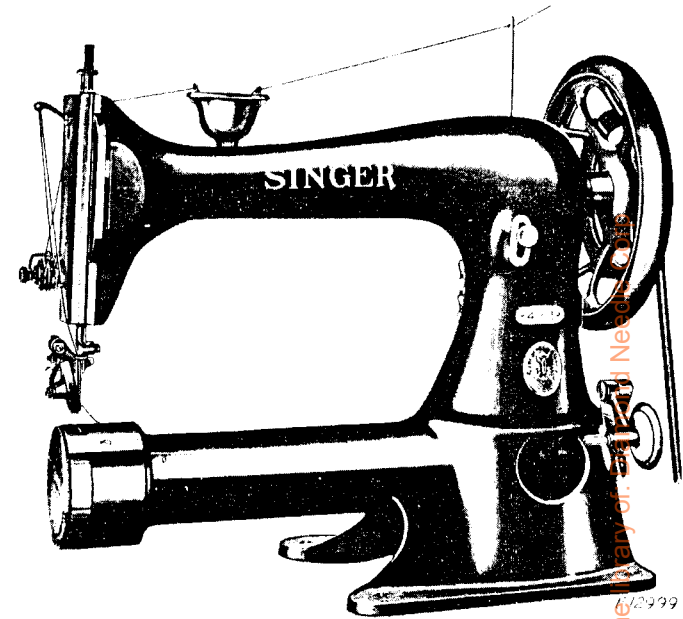
- 1 to 1500 and 50001 to 51500 are Screw Numbers.
- 1501 to 1800 are Nut Numbers.
- 1801 to 2000 are Roller Numbers.
- 2001 to 50000 and 52001 and upward are numbers of Machine Parts.

The figures in the second column refer only to the plates illustrating the parts, and are **NOT TO BE USED** in ordering.

Parts marked with an asterisk (*) are furnished only when repairs are made at factory.

LIST OF PARTS COMPLETE

FOR



MACHINE No. 43-1

FOR LEATHER. C. B., CAM ON NEEDLE BAR. DROP FEED AT LEFT OF NEEDLE. ROLLER PRESSER

| NO. | PLATE | NAME |
|--------|-------|--|
| *13044 | — | Arm with 4448 and 4449..... |
| 2002 | 686 | " Dowel Pin..... |
| 4448 | 695 | " Oil Tube for intermediate bearing..... |
| 123E | 691 | " Screw..... |
| 6109 | 696 | " Shaft for 3011..... |
| 6107 | 696 | " " " 5977..... |
| 3005 | 678 | " " Bushing (back)..... |
| 448C | 691 | " " " " Set Screw..... |
| *4449 | — | " " " (front)..... |
| 144b | 691 | " " Screw..... |

| NO. | PLATE | NAME |
|--------|-------|--|
| 4288 | 678 | Arm Side Cover..... |
| 286D | 692 | " " " Thumb Screw..... |
| 5811 | 695 | " Spool Pin and Thread Eyelet..... |
| 8879 | 7801 | " " " Washer (cloth)..... |
| 3011 | 696 | Balance Wheel (two speed) 3 in. and 5 in. pulleys, with two 448c..... |
| 5977 | 696 | Balance Wheel (two speed) for 5981..... |
| 448c | 691 | " " " Set Screw..... |
| 13045 | 718 | Cloth Plate..... |
| 13046 | 718 | " " Bracket with 1107c..... |
| 1107c | 724 | " " " Set Screw..... |
| 13047 | 718 | " " Slide..... |
| 3286 | 723 | " " " Spring..... |
| 240D | 691 | " " " " Screw..... |
| 13048 | — | Cloth Plate complete, Nos. 3286, 13045, 13047 and two 240D..... |
| 13049 | — | Cloth Plate with Bracket complete, Nos. 13046, 13048 and two 389F..... |
| 389F | 724 | Cloth Plate Screw..... |
| 13002 | 717 | Crank Connecting Rod with 4349 and two 158E..... |
| *4349 | — | Crank Connecting Rod Cap..... |
| 158E | 691 | " " " " Screw..... |
| 566c | 692 | " " " Hinge Screw..... |
| 1513J | 693 | " " " " " Nut |
| *13001 | — | Cylinder, 3¼ in. diam..... |
| 5978 | 696 | Driving Flange with two 435c..... |
| 5979 | 3632 | " " Latch..... |
| 136F | 691 | " " " Hinge Screw..... |
| 5980 | 3632 | " " " Spring..... |
| 330D | 692 | " " " " Screw..... |
| 435c | 691 | " " " Set Screw..... |
| 5993 | — | Driving Flange complete, Nos. 136F, 330D and 5978 to 5980..... |
| 5808 | 696 | Face Plate..... |
| 8177 | — | " " 5808 with 2105..... |
| 8180 | — | Face Plate complete, Nos. 448c, 2107, 2127, 5797, 5989, 5991, 8177 and two 233D..... |
| 164D | 691 | Face Plate Screw..... |
| 2107 | 686 | " " Thread Guard..... |
| 233D | 691 | " " " " Screw..... |
| 13018 | 715 | Feed Cam with 446c..... |
| 446c | 691 | " " Set Screw..... |
| 3033 | 3632 | " Connecting Link..... |
| 375c | 692 | " " " Hinge Screw..... |
| 1518E | 693 | " " " " " Nut |

| NO. | PLATE | NAME |
|--------|-------|---|
| 13004 | 716 | Feed Dog, 12 teeth..... |
| 13005 | 715 | " " Carrier..... |
| 805c | 691 | " " Screw..... |
| 13006 | 717 | " Forked Connection..... |
| 375c | 692 | " " " Hinge Screw..... |
| 1518E | 693 | " " " " " Nut |
| 3039 | 3632 | " Regulator..... |
| 1128E | 3632 | " " Hinge Screw..... |
| 818D | 692 | " " Thumb Screw..... |
| 13007 | 717 | " Rock Shaft..... |
| 13008 | 715 | " " " Crank..... |
| 156c | 691 | " " " " Position Screw..... |
| 190D | 691 | " " " " Set Screw..... |
| 5981 | — | Loose Wheel Attachment complete, Nos. 5977 and 5993..... |
| 5465 | 678 | Needle Bar..... |
| 5457 | 681 | " " Cam with two 175E..... |
| 175E | 691 | " " " Clamping Screw..... |
| 5458 | 681 | " " " Guide..... |
| 647c | 724 | " " " " Screw..... |
| 1860 | 693 | " " " Roller and Stud..... |
| 453c | 692 | " " " " " Set Screw |
| 290E | 692 | " " Screw Bushing..... |
| 4803 | 686 | Needle Clamp complete, Nos. 651D, 808F and 4802..... |
| 808F | 691 | Needle Clamp Screw..... |
| 4802 | 686 | " " Thread Guide..... |
| 651D | 692 | " " " " Screw..... |
| 6436 | 727 | Oil Cup with 1111E and three 6437..... |
| 1111E | 724 | " " Screw Stud..... |
| 6437 | 723 | " " Thread Eyelet..... |
| *13009 | 715 | Oscillating Rock Shaft with 11165..... |
| 13062 | — | " " " 13009 with 56812 |
| 3052 | 678 | " " " Hinge Pin..... |
| 56812 | — | " " " " " 3 0 5 2 with 1513J..... |
| 1513J | 693 | Oscillating Rock Shaft Hinge Pin Nut... |
| 11165 | 695 | " " " Oil Pad..... |
| 13022 | 717 | " Shaft..... |
| 5966 | — | " " Crank..... |
| 5967 | 681 | Oscillating Shaft Crank complete, Nos. 453c, 1513J, 1885 and 5966..... |
| 2049 | 686 | Oscillating Shaft Crank Pin..... |
| 1885 | 693 | " " " Roller with 190D, 1054c and 5968..... |
| 190D | 691 | Oscillating Shaft Crank Roller Cap Screw |

| NO. | PLATE | NAME |
|-------|-------|--|
| 5968 | 686 | Oscillating Shaft Crank Roller Cap Screw Washer |
| 1054c | 3632 | Oscillating Shaft Crank Roller Screw Stud |
| 1513j | 693 | " " " " " " |
| | | Nut |
| 453c | 692 | Oscillating Shaft Crank Set Screw |
| 3054 | 678 | Presser Bar |
| 5990 | 681 | " " Lifter |
| 689c | 691 | " " " Screw |
| 1520E | 693 | " " " Nut |
| 5827 | 727 | " " Lifting Bracket with two 453c |
| 453c | 692 | " " " " Set Screw |
| 290E | 692 | " " Screw Bushing |
| 6466 | 678 | " " Spring |
| 2070 | 686 | " " Washer |
| 5971 | 728 | " Foot (long shank) |
| 190D | 691 | " " Screw |
| 262j | 692 | Pressure Regulating Thumb Screw |
| 1875 | 723 | Roller, 1½ in. diam., with 634D and 1528J |
| 8152 | 723 | " Arm |
| 440F | 691 | " " Adjusting Screw |
| 1547j | 693 | " " " " Nut |
| 2206 | 723 | " " Bracket |
| 2205 | 695 | " " Lock Spring |
| 176D | 691 | " " " " Screw |
| 1549j | 693 | " " " " " Nut |
| 316F | 692 | " " Screw Centre |
| 1547j | 693 | " " " " Nut |
| 634D | 692 | " " Screw |
| 1528j | 693 | " " Nut |
| 5964 | — | Roller Presser complete, 1½ in. roller, Nos. 176D, 440F, 1549j, 1875, 2205, 2206, 8152, two 316F and three 1547j |
| 190D | 691 | Roller Presser Screw |
| 5810 | 684 | Shuttle Bobbin |
| 5786 | 684 | " " Case Latch |
| 5787 | 684 | " " " " Lever |
| 5788 | 684 | " " " " " Fulerum Pin |
| 5838 | 684 | Shuttle Bobbin Case Latch Spring |
| 592E | 692 | " " " " Stop Screw |
| 5785 | — | " " " " Hinge, Nos. 5786 to 5788 |
| 5789 | 684 | Shuttle Bobbin Case Position Finger |
| 5933 | 684 | " " " " " Rivet |
| 5784 | 684 | Shuttle Bobbin Case complete, Nos. 591F, 592E, 5785, 5789, 5838, 5933 and 5935 |

| NO. | PLATE | NAME |
|-------|-------|---|
| 5934 | 684 | Shuttle Body |
| 591F | 692 | " Tension Regulating Screw |
| 5935 | 684 | " " Spring |
| 5783 | — | Shuttle, 2½ in. diam., Nos. 5784, 5810 and 5934 |
| 13038 | 715 | Shuttle Driver and Feed Lifting Cam |
| 2022 | 723 | " " " " " " Pin |
| 13012 | 715 | " Race Ring |
| 13013 | 715 | " " " Cap |
| 13015 | 721 | " " " " Latch |
| 240D | 691 | " " " " " Screw |
| 13014 | — | Shuttle Race Ring Cap complete, Nos. 13013, 13015 and two 240D |
| 102D | 724 | Shuttle Race Ring Cap Screw |
| 145D | 691 | " " " Screw |
| 1560c | 693 | Tension Regulating Thumb Nut |
| 817c | 693 | " Screw Stud |
| 8183 | — | " " " 817c with 1560c |
| 448c | 691 | " " " Set Screw |
| 2103 | 685 | " Spring |
| 2105 | 686 | " Thread Guard |
| 5983 | 686 | " Washer (felt) |
| 5984 | 686 | " " (steel) |
| 5795 | 686 | " Wheel with 5796 |
| *5796 | — | " " Flange |
| 5797 | — | Tension complete (wheel) Nos. 2103, 5795, 8183 and two each 5983 and 5984 |
| 12296 | 686 | Thread Eyelet (side of arm) |
| 2455 | 685 | " Retaining Disc |
| 1562j | 693 | " " Regulating Thumb Nut |
| 418E | 693 | " " Screw Stud |
| 10141 | 685 | " " Spring |
| 5989 | — | Thread Retainer complete, Nos. 418E, 1562j, 10141 and two 2455 |
| 5952 | 678 | Thread Take-up Cam with 446c and 453c |
| 3012 | 3636 | " " " Pin |
| 446c | 691 | " " " Set Screw |
| *5954 | 678 | " " Lever with 1819 |
| 8161 | — | " " " 5954 with 1088c |
| 1088c | 3636 | " " " Hinge Screw |
| 1819 | 693 | " " " Roller and Stud |
| 5991 | 686 | " " Spring |
| 2127 | 686 | " " " Regulator Plate |
| 233D | 691 | " " " " " Adjusting Screw |

| NO. | PLATE | NAME |
|-------|-------|-----------------------------|
| 13016 | 716 | Throat Plate for 13004..... |
| 742F | 692 | " " Screw..... |
| 6053 | 3543 | Drip Pan..... |

SPECIAL PARTS FOR CAP WORK

| | | |
|-------|-----|---|
| 13093 | 729 | Guide..... |
| 13094 | 729 | Shuttle Race Cap..... |
| 13095 | — | Shuttle Race Cap complete, Nos. 13015, 13094 and two 240D..... |
| 13096 | 729 | Throat Plate for 13004..... |
| 13097 | 729 | " " Extension, for attaching visors to uniform caps..... |

LIST OF PARTS COMPLETE

FOR

MACHINE No. 43-2FOR CLOTH. LINK NEEDLE BAR CONNECTION,
DROP FEED, BOTH SIDES OF NEEDLE

| NO. | PLATE | NAME |
|--------|-------|---|
| *13019 | — | Arm with 4448 and 4449..... |
| 2002 | 686 | " Dowel Pin..... |
| 4448 | 695 | " Oil Tube for intermediate bearing .. |
| 123E | 691 | " Screw..... |
| 6109 | 696 | " Shaft for 3011..... |
| 6107 | 696 | " " " 5977..... |
| 3005 | 678 | " " Bushing (back)..... |
| 448c | 691 | " " " " Set Screw..... |
| *4449 | — | " " " (front)..... |
| 144D | 691 | " " Screw..... |
| 4288 | 678 | " Side Cover..... |
| 286D | 692 | " " " Thumb Screw..... |
| 5811 | 695 | " Spool Pin and Thread Eyelet..... |
| 8879 | 7801 | " " " Washer (cloth)..... |
| 3011 | 696 | Balance Wheel (two speed) 3 in. and 5 in. pulleys, with two 448c..... |
| 5977 | 696 | Balance Wheel (two speed) for 5981..... |
| 448c | 691 | " " " Set Screw..... |
| 13045 | 718 | Cloth Plate..... |
| 13046 | 718 | " " Bracket with 1107c..... |
| 1107c | 724 | " " " Set Screw..... |
| 13047 | 718 | " " Slide..... |
| 3286 | 723 | " " " Spring..... |
| 240D | 691 | " " " " Screw..... |
| 13048 | — | Cloth Plate complete, Nos. 3286, 13045, 13047 and two 240D..... |
| 13049 | — | Cloth Plate with Bracket complete, Nos. 13046, 13048 and two 389F..... |
| 389F | 724 | Cloth Plate Screw..... |
| 13002 | 717 | Crank Connecting Rod with 4349 and two 158E..... |
| *4349 | — | Crank Connecting Rod Cap..... |
| 158E | 691 | " " " " Screw..... |
| 566c | 692 | " " " Hinge Screw..... |
| 1513J | 693 | " " " " " Nut |

From the library of: Diamond Needle Corp

| NO. | PLATE | NAME |
|--------|-------|--|
| *13001 | — | Cylinder, 3¼ in. diam..... |
| 5978 | 696 | Driving Flange with two 435c..... |
| 5979 | 3632 | " " Latch..... |
| 136F | 691 | " " " Hinge Screw..... |
| 5980 | 3632 | " " " Spring..... |
| 330D | 692 | " " " " Screw..... |
| 435c | 691 | " " " Set Screw..... |
| 5993 | — | Driving Flange complete, Nos. 136F, 330D and 5978 to 5980..... |
| 5982 | 696 | Face Plate..... |
| 8173 | — | " " 5982 with 2105..... |
| 8179 | — | Face Plate complete, Nos. 448c, 2107, 2127, 5797, 5989, 5991, 8173 and two 233D..... |
| 164D | 691 | Face Plate Screw..... |
| 2107 | 686 | " " Thread Guard..... |
| 233D | 691 | " " " " Screw..... |
| 3032 | 678 | Feed Cam with 446c..... |
| 446c | 691 | " " Set Screw..... |
| 3033 | 3632 | " Connecting Link..... |
| 375c | 692 | " " " Hinge Screw..... |
| 1518E | 693 | " " " " " Nut..... |
| 13028 | 716 | " Dog, two rows of teeth..... |
| 13056 | 726 | " "..... |
| 13005 | 715 | " " Carrier..... |
| 805c | 691 | " " Screw..... |
| 13006 | 717 | " Forked Connection..... |
| 375c | 692 | " " " Hinge Screw..... |
| 1518E | 693 | " " " " " Nut..... |
| 3039 | 3632 | " Regulator..... |
| 1128E | 3632 | " " Hinge Screw..... |
| 818D | 692 | " " Thumb Screw..... |
| 13007 | 717 | " Rock Shaft..... |
| 13008 | 715 | " " " Crank..... |
| 156c | 691 | " " " " Position Screw..... |
| 190D | 691 | " " " " Set Screw..... |
| 5981 | — | Loose Wheel Attachment complete, Nos. 5977 and 5993..... |
| 5465 | 678 | Needle Bar..... |
| *3045 | 681 | " " Connecting Link..... |
| 56773 | — | " " " " 3045 with 2052..... |
| 377c | 692 | Needle Bar Connecting Link Hinge Screw..... |
| 1518E | 693 | " " " " " " " " " " " Nut..... |
| 2052 | 723 | Needle Bar Connecting Stud with 155c..... |
| 155c | 691 | " " " " " Set Screw..... |

| NO. | PLATE | NAME |
|--------|-------|---|
| 290E | 692 | Needle Bar Screw Bushing..... |
| 4803 | 686 | Needle Clamp complete, Nos. 651D, 808F and 4802..... |
| 808F | 691 | Needle Clamp Screw..... |
| 4802 | 686 | " " Thread Guide..... |
| 651D | 692 | " " " " Screw..... |
| 6436 | 727 | Oil Cup with 1111E and three 6437..... |
| 1111E | 724 | " " Screw Stud..... |
| 6437 | 723 | " " Thread Eyelet..... |
| *13009 | 715 | Oscillating Rock Shaft with 11165..... |
| 13062 | — | " " " 13009 with 56812.. |
| 3052 | 678 | " " " Hinge Pin..... |
| 56812 | — | " " " " " " 3 0 5 2 with 1513J..... |
| 1513J | 693 | Oscillating Rock Shaft Hinge Pin Nut..... |
| 11165 | 695 | " " " Oil Pad..... |
| 13022 | 717 | " Shaft..... |
| 5966 | — | " " Crank..... |
| 5967 | 681 | Oscillating Shaft Crank complete, Nos. 453c, 1513J, 1885 and 5966..... |
| 2049 | 3632 | Oscillating Shaft Crank Pin..... |
| 1885 | 693 | " " " Roller with 190D, 1054c and 5968..... |
| 190D | 691 | Oscillating Shaft Crank Roller Cap Screw..... |
| 5968 | 3632 | " " " " " " " " " " " Washer..... |
| 1054c | 3632 | Oscillating Shaft Crank Roller Screw Stud..... |
| 1513J | 693 | " " " " " " " " " " " Nut..... |
| 453c | 692 | Oscillating Shaft Crank Set Screw..... |
| 3054 | 678 | Presser Bar..... |
| 5990 | 681 | " " Lifter..... |
| 689c | 691 | " " " Screw..... |
| 1520E | 693 | " " " " Nut..... |
| 5608 | 727 | " " Lifting Bracket with 453c..... |
| 453c | 692 | " " " " Set Screw..... |
| 290E | 692 | " " Screw Bushing..... |
| 3056 | 678 | " " Spring..... |
| 2070 | 686 | " " " Washer..... |
| 5922 | — | " Foot Bracket..... |
| 5924 | — | " " Plate..... |
| 5923 | 686 | " " " Hinge Pin..... |
| 5921 | 728 | Presser Foot (hinged) complete, Nos. 5922 to 5924..... |
| 13029 | 716 | Presser Foot (solid) short shank..... |
| 190D | 691 | " " Screw..... |
| 262J | 692 | Pressure Regulating Thumb Screw..... |

LIST OF PARTS COMPLETE

FOR

MACHINE No. 43-3

FOR LEATHER. LONG BEAK CYLINDER SHUTTLE, DROP FEED
BOTH SIDES OF NEEDLE, VIBRATING PRESSER.

| NO. | PLATE | NAME |
|--------|-------|--|
| *13039 | — | Arm with 4448 and 4449 |
| 2002 | 686 | " Dowel Pin |
| 4448 | 695 | " Oil Tube for intermediate bearing... |
| 123E | 691 | " Screw |
| 6109 | 696 | " Shaft for 3011 |
| 6107 | 696 | " " " 5977 |
| 3005 | 678 | " " Bushing (back) |
| 448c | 691 | " " " " Set Screw |
| *4449 | — | " " " (front) |
| 144d | 691 | " " Screw |
| 4288 | 678 | " Side Cover |
| 286d | 692 | " " " Thumb Screw |
| 5811 | 695 | " Spool Pin and Thread Eyelet |
| 8879 | 7801 | " " " Washer (cloth) |
| 3011 | 696 | Balance Wheel (two speed) 3 in. and 5 in. pulleys, with two 448c |
| 5977 | 696 | Balance Wheel (two speed) for 5981 |
| 448c | 691 | " " Set Screw |
| 13045 | 718 | Cloth Plate |
| 13052 | 718 | " " Bracket with 1107c |
| 1107c | 724 | " " " Set Screw |
| 13047 | 718 | " " Slide |
| 3286 | 723 | " " " Spring |
| 240d | 691 | " " " " Screw |
| 13048 | — | Cloth Plate complete, Nos. 3286, 13045, 13047 and two 240d |
| 13053 | — | Cloth Plate with Bracket complete, Nos. 13048, 13052 and two 389F |
| 389F | 724 | Cloth Plate Screw |
| 13002 | 717 | Crank Connecting Rod with 4349 and two 158E |
| *4349 | — | Crank Connecting Rod Cap |
| 158E | 691 | " " " " Screw |
| 566c | 692 | " " " Hinge Screw |
| 1513j | 693 | " " " " " Nut |

| NO. | PLATE | NAME |
|--------|-------|--|
| *13020 | — | Cylinder, 3¼ in. diam |
| 5978 | 696 | Driving Flange with two 435c |
| 5979 | 3632 | " " Latch |
| 136F | 691 | " " " Hinge Screw |
| 5980 | 3632 | " " " Spring |
| 330d | 692 | " " " " Screw |
| 435c | 691 | " " " Set Screw |
| 5993 | — | Driving Flange complete, Nos. 136F, 330d and 5978 to 5980 |
| 5820 | 727 | Face Plate |
| *8181 | — | " " 5820 with 2105 |
| 8182 | — | Face Plate complete, Nos. 233d, 448c, 2127, 5797, 5989, 5991 and 8181 |
| 164d | 691 | Face Plate Screw |
| 3032 | 678 | Feed Cam with 446c |
| 446c | 691 | " " Set Screw |
| 3033 | 3632 | " Connecting Link |
| 375c | 692 | " " " Hinge Screw |
| 1518E | 693 | " " " " " Nut |
| 13050 | 726 | " Dog, 12 teeth, double rows of teeth. |
| 13054 | 726 | " " 8 teeth |
| 13060 | 728 | " " 12 spiked teeth |
| 13005 | 715 | " " Carrier |
| 805c | 691 | " " Screw |
| 13006 | 717 | " Forked Connection |
| 375c | 692 | " " " Hinge Screw |
| 1518E | 693 | " " " " " Nut |
| 3039 | 3632 | " Regulator |
| 1128E | 3632 | " " Hinge Screw |
| 818d | 692 | " " Thumb Screw |
| 13007 | 717 | " Rock Shaft |
| 13008 | 715 | " " " Crank |
| 156c | 691 | " " " " Position Screw |
| 190d | 691 | " " " " Set Screw |
| 5826 | 676 | Lifting Cam |
| 902E | 3646 | " " Screw |
| 5821 | 727 | " Lever |
| 5878 | 3646 | " " Adjusting Screw Head |
| 2653 | 3646 | " " " " " Rivet |
| 1068d | 3646 | " " " Screw |
| 5879 | 3646 | " " " Slide |
| 5823 | 676 | " " " " Roller |
| 5824 | 676 | " " " " " Pin |
| 5835 | 676 | " " Hinge Bracket |
| 5836 | — | " " " " 5835 with 4810 |
| 180d | 691 | Lifting Lever Hinge Bracket Screw |

| NO. | PLATE | NAME |
|--------|-------|---|
| 4810 | 723 | Lifting Lever Hinge Stud..... |
| 207D | 691 | " " " " Screw..... |
| 3146 | 686 | " " " " " Washer.. |
| 5825 | — | Lifting Lever complete, Nos. 1068D, 2653, 5821, 5823, 5824, 5878 and 5879..... |
| 7299 | 727 | Lifting Presser Bar..... |
| 5990 | 681 | " " " " Lifter..... |
| 689c | 691 | " " " " " Screw..... |
| 1520E | 693 | " " " " " Nut..... |
| 5827 | 727 | " " " " Lifting Bracket with two 453c..... |
| 453c | 692 | Lifting Presser Bar Lifting Bracket Set Screw..... |
| 290E | 692 | Lifting Presser Bar Screw Bushing..... |
| 3056 | 678 | " " " " Spring..... |
| 2070 | 686 | " " " " " Washer..... |
| 5981 | — | Loose Wheel Attachment complete, Nos. 5977 and 5993..... |
| 5465 | 678 | Needle Bar..... |
| *3045 | 681 | " " " " Connecting Link..... |
| 56815 | — | " " " " " 3045 with 3147..... |
| 377c | 692 | Needle Bar Connecting Link Hinge Screw..... |
| 1518E | 693 | " " " " " " " Nut..... |
| 3147 | 3646 | Needle Bar Connecting Stud with 155c... |
| 155c | 691 | " " " " " Set Screw... |
| 290E | 692 | " " " " " Screw Bushing..... |
| 4803 | 686 | Needle Clamp complete, Nos. 651D, 808F and 4802..... |
| 808F | 691 | Needle Clamp Screw..... |
| 4802 | 686 | " " " " Thread Guide..... |
| 651D | 692 | " " " " " Screw..... |
| 6436 | 727 | Oil Cup with 1111E and three 6437..... |
| 1111E | 724 | " " " " " Screw Stud..... |
| 6437 | 723 | " " " " " Thread Eyelet..... |
| *13009 | 715 | Oscillating Rock Shaft with 11165..... |
| 13062 | — | " " " " " 13009 with 56812..... |
| 3052 | 678 | " " " " " Hinge Pin..... |
| 56812 | — | " " " " " " 3052 with 1513J..... |
| 1513J | 693 | Oscillating Rock Shaft Hinge Pin Nut... |
| 11165 | 695 | " " " " " Oil Pad..... |
| 13063 | 727 | " " " " " Shaft..... |
| 5999 | — | " " " " " Crank..... |
| 6000 | 3632 | Oscillating Shaft Crank complete, Nos. 453c, 1513J, 1885 and 5999..... |

| NO. | PLATE | NAME |
|-------|-------|---|
| 2049 | 3632 | Oscillating Shaft Crank Pin..... |
| 1885 | 693 | " " " " " Roller with 190D, 1054c and 5968..... |
| 190D | 691 | Oscillating Shaft Crank Roller Cap Screw..... |
| 5968 | 3632 | " " " " " " " Washer..... |
| 1054c | 3632 | Oscillating Shaft Crank Roller Screw Stud..... |
| 1513J | 693 | " " " " " " " Nut..... |
| 453c | 692 | Oscillating Shaft Crank Set Screw..... |
| 262J | 692 | Pressure Regulating Thumb Screw..... |
| 14535 | 685 | Shuttle Bobbin..... |
| 8187 | 730 | " " " " " Cylinder..... |
| *8194 | — | " " " " " 8187 with 773F and 8188..... |
| 12000 | 685 | " " " " " Hinge Pin..... |
| 12001 | 685 | " " " " " Latch..... |
| 12002 | 685 | " " " " " Pin..... |
| 11854 | 730 | " " " " " Spring..... |
| 590D | 692 | " " " " " " Screw..... |
| 5752 | 685 | " " " " " Frame..... |
| *8162 | — | " " " " " 5752 with 590D, 11854, 12001 and 12002..... |
| 773F | 692 | Shuttle Tension Regulating Screw..... |
| 8188 | 730 | " " " " " Spring..... |
| 8189 | 730 | Shuttle (cylinder) 2½ in. diam., complete, Nos. 8162, 8194, 12000 and 14535..... |
| 13023 | 715 | Shuttle Driver and Feed Lifting Eccentric..... |
| 2022 | 723 | " " " " " " " " Pin..... |
| 13024 | 715 | Shuttle Race..... |
| 13025 | 717 | " " " " " Cap..... |
| 13026 | — | Shuttle Race Cap complete, Nos. 13015, 13025 and two 240D..... |
| 13015 | 721 | Shuttle Race Cap Latch..... |
| 240D | 691 | " " " " " " " Screw..... |
| 102D | 724 | " " " " " " " Screw..... |
| 127E | 691 | " " " " " " " Screw..... |
| 1560c | 693 | Tension Regulating Thumb Nut..... |
| 817c | 693 | " " " " " " " Screw Stud..... |
| 8183 | — | " " " " " 817c with 1560c..... |
| 448c | 691 | " " " " " " " Set Screw..... |
| 2103 | 685 | " " " " " Spring..... |
| 2105 | 686 | " " " " " Thread Guard..... |
| 5983 | 686 | " " " " " Washer (felt)..... |
| 5984 | 686 | " " " " " (steel)..... |
| 5795 | 686 | " " " " " Wheel with 5796..... |
| *5796 | — | " " " " " Flange..... |

| NO. | PLATE | NAME |
|-------|-------|--|
| 5797 | — | Tension complete (wheel) Nos. 2103, 5795, 8183 and two each 5983 and 5984. |
| 12296 | 686 | Thread Eyelet (side of arm) |
| 2455 | 685 | " Retainer Disc |
| 1562J | 693 | " " Regulating Thumb Nut. |
| 418E | 693 | " " Screw Stud |
| 10141 | 685 | " " Spring |
| 5989 | — | Thread Retainer complete, Nos. 418E, 1562J, 10141 and two 2455. |
| 13043 | 720 | Thread Take-up Cam with 446c, 902E and 5826. |
| 3012 | 3636 | Thread Take-up Cam Pin |
| 446c | 691 | " " " Set Screw |
| 13041 | 720 | " " Lever with 1819. |
| 1088c | 3636 | " " " Hinge Screw |
| 1819 | 693 | " " " Roller and Stud |
| 5991 | 686 | " " Spring |
| 2127 | 686 | " " " Regulator Plate |
| 233D | 691 | " " " " " " |
| | | Adjusting Screw |
| 13051 | 726 | Throat Plate for 13050, 13054 and 13060. |
| 742F | 692 | " " Screw |
| 5885 | 3646 | Vibrating Presser Bar |
| 5886 | — | Vibrating Presser Bar complete, Nos. 191F, 5885 and 5887. |
| 5887 | 3646 | Vibrating Presser Foot |
| 191F | 691 | " " " Screw |
| 5837 | 676 | " " Guide Bracket |
| 190D | 691 | " " " " Screw |
| 5830 | 676 | " " Hinge Bracket with 453c |
| 212D | 691 | Vibrating Presser Hinge Bracket Cap Screw |
| 453c | 692 | Vibrating Presser Hinge Bracket Set Screw |
| 5831 | 676 | Vibrating Presser Spring |
| 233D | 691 | " " " Screw |
| 2269 | 686 | " " Stop Pin |
| 6053 | 3543 | Drip Pan |

LIST OF PARTS COMPLETE FOR MACHINE No. 43-4

FOR LEATHER. LONG BEAK CYLINDER SHUTTLE, LINK
NEEDLE BAR CONNECTION, DROP FEED AT LEFT OF
NEEDLE, ROLLER PRESSER.

| NO. | PLATE | NAME |
|--------|-------|---|
| *13019 | — | Arm with 4448 and 4449 |
| 2002 | 686 | " Dowel Pin |
| 4448 | 695 | " Oil Tube for intermediate bearing |
| 123E | 691 | " Screw |
| 6109 | 696 | " Shaft for 3011 |
| 6107 | 696 | " " " 5977 |
| 3005 | 678 | " " Bushing (back) |
| 448c | 691 | " " " " Set Screw |
| *4449 | — | " " " (front) |
| 144D | 691 | " " Screw |
| 4288 | 678 | " Side Cover |
| 286D | 692 | " " " Thumb Screw |
| 5811 | 695 | " Spool Pin and Thread Eyelet |
| 8879 | 7801 | " " " Washer (cloth) |
| 3011 | 696 | Balance Wheel (two speed) 3 in. and 5 in. pulleys, with two 448c |
| 5977 | 696 | Balance Wheel (two speed) for 5981 |
| 448c | 691 | " " Set Screw |
| 13045 | 718 | Cloth Plate |
| 13052 | 718 | " " Bracket with 1107c |
| 1107c | 724 | " " " Set Screw |
| 13047 | 718 | " " Slide |
| 3286 | 723 | " " " Spring |
| 240D | 691 | " " " " Screw |
| 13048 | — | Cloth Plate complete, Nos. 3286, 13045, 13047 and two 240D |
| 13053 | — | Cloth Plate with Bracket complete, Nos. 13048, 13052 and two 389F |
| 389F | 724 | Cloth Plate Screw |
| 13002 | 717 | Crank Connecting Rod with 4349 and two 158E |
| *4349 | — | Crank Connecting Rod Cap |
| 158E | 691 | " " " " Screw |
| 566c | 692 | " " " Hinge Screw |
| 1513J | 693 | " " " " " Nut |

| NO. | PLATE | NAME |
|--------|-------|--|
| *13020 | — | Cylinder, 3¼ in. diam. |
| 5978 | 696 | Driving Flange with two 435c. |
| 5979 | 3632 | “ “ Latch. |
| 136F | 691 | “ “ “ Hinge Screw. |
| 5980 | 3632 | “ “ “ Spring. |
| 330D | 692 | “ “ “ “ Screw. |
| 435c | 691 | “ “ “ Set Screw. |
| 5993 | — | Driving Flange complete, Nos. 136F, 330D and 5978 to 5980. |
| 5982 | 696 | Face Plate. |
| 8173 | — | “ “ 5982 with 2105. |
| 8179 | — | Face Plate complete, Nos. 448c, 2107, 2127, 5797, 5989, 5991, 8173 and two 233d. |
| 164D | 691 | Face Plate Screw. |
| 2107 | 686 | “ “ Thread Guard. |
| 233D | 691 | “ “ “ “ Screw. |
| 3032 | 678 | Feed Cam with 446c. |
| 446c | 691 | “ “ Set Screw. |
| 3033 | 3632 | “ Connecting Link. |
| 375c | 692 | “ “ “ Hinge Screw. |
| 1518E | 693 | “ “ “ “ “ Nut. |
| 13058 | 728 | “ Dog, 12 teeth. |
| 13061 | 728 | “ “ 6 teeth. |
| 13005 | 715 | “ “ Carrier. |
| 805c | 691 | “ “ Screw. |
| 13006 | 717 | “ Forked Connection. |
| 375c | 692 | “ “ “ Hinge Screw. |
| 1518E | 693 | “ “ “ “ “ Nut. |
| 3039 | 3632 | “ Regulator. |
| 1128E | 3632 | “ “ Hinge Screw. |
| 818D | 692 | “ “ Thumb Screw. |
| 13007 | 717 | “ Rock Shaft. |
| 13008 | 715 | “ “ “ Crank. |
| 156c | 691 | “ “ “ “ Position Screw. |
| 190D | 691 | “ “ “ “ Set Screw. |
| 5981 | — | Loose Wheel Attachment complete, Nos. 5977 and 5993. |
| 5465 | 678 | Needle Bar. |
| *3045 | 681 | “ “ Connecting Link. |
| 56773 | — | “ “ “ “ 3045 with 2052. |
| 377c | 692 | Needle Bar Connecting Link Hinge Screw. |
| 1518E | 693 | “ “ “ “ “ “ Nut. |
| 2052 | 683 | Needle Bar Connecting Stud with 155c. |
| 155c | 691 | “ “ “ “ Set Screw. |

| NO. | PLATE | NAME |
|--------|-------|--|
| 290E | 692 | Needle Bar Screw Bushing. |
| 4803 | 686 | Needle Clamp complete, Nos. 651D, 808F and 4802. |
| 808F | 691 | Needle Clamp Screw. |
| 4802 | 686 | “ “ Thread Guide. |
| 651D | 692 | “ “ “ “ Screw. |
| 6436 | 727 | Oil Cup with 1111E and three 6437. |
| 1111E | 724 | “ “ Screw Stud. |
| 6437 | 723 | “ “ Thread Eyelet. |
| *13009 | 715 | Oscillating Rock Shaft with 11165. |
| 13062 | — | “ “ “ 13009 with 56812. |
| 3052 | 678 | “ “ “ Hinge Pin. |
| 56812 | — | “ “ “ “ “ 3052 with 1513J. |
| 1513J | 693 | Oscillating Rock Shaft Hinge Pin Nut. |
| 11165 | 695 | “ “ “ Oil Pad. |
| 13063 | 727 | “ Shaft. |
| 5999 | — | “ Crank. |
| 6000 | 3632 | Oscillating Shaft Crank complete, Nos. 453c, 1513J, 1885 and 5999. |
| 2049 | 686 | Oscillating Shaft Crank Pin. |
| 1885 | 693 | “ “ “ Roller with 190D, 1054c and 5968. |
| 190D | 691 | Oscillating Shaft Crank Roller Cap Screw. |
| 5968 | 686 | “ “ “ “ “ “ Washer. |
| 1054c | 3632 | Oscillating Shaft Crank Roller Screw Stud. |
| 1513J | 693 | “ “ “ “ “ “ Nut. |
| 453c | 692 | Oscillating Shaft Crank Set Screw. |
| 3054 | 678 | Presser Bar. |
| 5990 | 681 | “ “ Lifter. |
| 689c | 691 | “ “ “ Screw. |
| 1520E | 693 | “ “ “ “ Nut. |
| 5608 | 727 | “ “ Lifting Bracket with 453c. |
| 453c | 692 | “ “ “ “ Set Screw. |
| 290E | 692 | “ “ Screw Bushing. |
| 3056 | 678 | “ “ Spring. |
| 2070 | 686 | “ “ Washer. |
| 5971 | 728 | “ Foot (long shank). |
| 190D | 691 | “ “ Screw. |
| 262J | 692 | Pressure Regulating Thumb Screw. |
| 1875 | 723 | Roller, 1½ in. diam., with 634D and 1528J. |
| 8152 | 723 | “ Arm. |
| 440F | 691 | “ “ Adjusting Screw. |
| 1517J | 693 | “ “ “ “ Nut. |
| 2206 | 723 | “ “ Bracket. |

| NO. | PLATE | NAME |
|-------|-------|--|
| 2205 | 695 | Roller Arm Lock Spring |
| 176D | 691 | " " " " Screw |
| 1549J | 693 | " " " " Nut |
| 316F | 692 | " " Screw Centre |
| 1547J | 693 | " " " " Nut |
| 634D | 692 | " Screw |
| 1528J | 693 | " " Nut |
| 5964 | — | Roller Presser complete, 1½ in. roller, Nos. 176D, 440F, 1549J, 1875, 2205, 2206, 8152, two 316F and three 1547J |
| 190D | 691 | Roller Presser Screw |
| 14535 | 685 | Shuttle Bobbin |
| 8187 | 730 | " Cylinder |
| *8194 | — | " " 8187 with 773F and 8188 |
| 12000 | 685 | " " Hinge Pin |
| 12001 | 685 | " " Latch |
| 12002 | 685 | " " Pin |
| 11854 | 730 | " " Spring |
| 590D | 692 | " " " " Screw |
| 5752 | 685 | " Frame |
| *8162 | — | " " 5752 with 590D, 11854, 12001 and 12002 |
| 773F | 692 | Shuttle Tension Regulating Screw |
| 8188 | 730 | " " Spring |
| 8189 | 730 | Shuttle (cylinder) 2½ in. diam., complete, Nos. 8162, 8194, 12000 and 14535 |
| 13023 | 715 | Shuttle Driver and Feed Lifting Eccentric |
| 2022 | 723 | " " " " " " " " |
| | | Pin |
| 13024 | 715 | Shuttle Race |
| 13025 | 717 | " " Cap |
| 13026 | — | Shuttle Race Cap complete, Nos. 13015, 13025 and two 240D |
| 13015 | 721 | Shuttle Race Cap Latch |
| 240D | 691 | " " " " Screw |
| 102D | 724 | " " " " Screw |
| 127E | 691 | " " Screw |
| 1560C | 693 | Tension Regulating Thumb Nut |
| 817C | 693 | " Screw Stud |
| 8183 | — | " " " 817C with 1560C |
| 448C | 691 | " " " Set Screw |
| 2103 | 685 | " Spring |
| 2105 | 686 | " Thread Guard |
| 5983 | 686 | " Washer (felt) |
| 5984 | 686 | " " (steel) |
| 5795 | 686 | " Wheel with 5796 |
| *5796 | — | " " Flange |

| NO. | PLATE | NAME |
|-------|-------|--|
| 5797 | — | Tension complete (wheel) Nos. 2103, 5795, 8183 and two each 5983 and 5984 |
| 12296 | 686 | Thread Eyelet (side of arm) |
| 2455 | 685 | " Retainer Disc |
| 1562J | 693 | " " Regulating Thumb Nut |
| 418E | 693 | " " Screw Stud |
| 10141 | 685 | " " Spring |
| 5989 | — | Thread Retainer complete, Nos. 418E, 1562J, 10141 and two 2455 |
| *8185 | — | Thread Take-up Cam |
| 5757 | 678 | " " " 8185 with 446C |
| 3012 | 3636 | " " " Pin |
| 446C | 691 | " " " Set Screw |
| *5758 | 678 | " " Lever with 1819 |
| 8159 | — | " " " 5758 with 1088C |
| 1088C | 3636 | " " " Hinge Screw |
| 1819 | 693 | " " " Roller and Stud |
| 5991 | 686 | " " Spring |
| 2127 | 686 | " " " Regulator Plate |
| 233D | 691 | " " " " " " |
| | | Adjusting Screw |
| 13059 | 728 | Throat Plate for 13058 and 13061 |
| 742F | 692 | " " " Screw |
| 6053 | 3543 | Drip Pan |

LIST OF PARTS COMPLETE

FOR

MACHINE No. 43-5

FOR CLOTH OR LEATHER. LONG BEAK CYLINDER SHUTTLE.
DROP FEED AT LEFT OF NEEDLE, ALTERNATING
PRESSERS.

| NO. | PLATE | NAME |
|--------|-------|---|
| *13055 | — | Arm with 4448 and 4449..... |
| 2002 | 3636 | " Dowel Pin..... |
| 4448 | 695 | " Oil Tube for intermediate bearing .. |
| 123E | 691 | " Screw..... |
| 6178 | 3543 | " Shaft for 3011..... |
| 6179 | 3543 | " " " 5977..... |
| 3005 | 678 | " " Bushing (back)..... |
| 448c | 691 | " " " " Set Screw..... |
| *4449 | — | " " " (front)..... |
| 144b | 691 | " " Screw..... |
| 4288 | 678 | " Side Cover..... |
| 286D | 692 | " " " Thumb Screw..... |
| 5811 | 695 | " Spool Pin and Thread Eyelet..... |
| 8879 | 7801 | " " " Washer (cloth)..... |
| 3011 | 696 | Balance Wheel (two speed) 3 in. and 5 in. pulleys, with two 448c..... |
| 5977 | 696 | Balance Wheel (two speed) for 5981..... |
| 448c | 691 | " " " Set Screw..... |
| 13045 | 718 | Cloth Plate..... |
| 13052 | 718 | " " Bracket with 1107c..... |
| 1107c | 724 | " " " Set Screw..... |
| 13047 | 718 | " " Slide..... |
| 3286 | 723 | " " " Spring..... |
| 240D | 691 | " " " " Screw..... |
| 13048 | — | Cloth Plate complete, Nos. 3286, 13045, 13047 and two 240D..... |
| 13053 | — | Cloth Plate with Bracket complete, Nos. 13048, 13052 and two 389F..... |
| 389F | 724 | Cloth Plate Screw..... |
| 13002 | 717 | Crank Connecting Rod with 4349 and two 158E..... |
| *4349 | — | Crank Connecting Rod Cap..... |
| 158E | 691 | " " " " Screw..... |
| 566c | 692 | " " " " Hinge Screw..... |
| 1513J | 693 | " " " " " Nut..... |

| NO. | PLATE | NAME |
|--------|-------|---|
| *13020 | — | Cylinder, 3¼ in. diam..... |
| 5978 | 696 | Driving Flange with two 435c..... |
| 5979 | 3632 | " " Latch..... |
| 136F | 691 | " " " Hinge Screw..... |
| 5980 | 3632 | " " " Spring..... |
| 330D | 692 | " " " " Screw..... |
| 435c | 691 | " " " Set Screw..... |
| 5993 | — | Driving Flange complete, Nos. 136F, 330D and 5978 to 5980..... |
| 5791 | 696 | Face Plate..... |
| 8174 | — | " " 5791 with 2105..... |
| 8178 | — | Face Plate complete, Nos. 233D, 448c, 2108, 2127, 5797, 5989, 5991 and 8174 |
| 175D | 691 | Face Plate Screw..... |
| 2108 | 3636 | " " Thread Guard..... |
| 3032 | 678 | Feed Cam with 446c..... |
| 446c | 691 | " " Set Screw..... |
| 3033 | 3632 | " Connecting Link..... |
| 375c | 692 | " " " Hinge Screw..... |
| 1518E | 693 | " " " " " Nut..... |
| 13050 | 726 | " Dog, 12 teeth, double rows of teeth |
| 13054 | 726 | " " 8 teeth..... |
| 13060 | 728 | " " 12 spiked teeth..... |
| 13005 | 715 | " " Carrier..... |
| 805c | 691 | " " Screw..... |
| 13006 | 717 | " Forked Connection..... |
| 375c | 692 | " " " Hinge Screw..... |
| 1518E | 693 | " " " " " Nut..... |
| 3039 | 3632 | " Regulator..... |
| 1128E | 3632 | " " Hinge Screw..... |
| 818D | 692 | " " Thumb Screw..... |
| 13007 | 717 | " Rock Shaft..... |
| 13008 | 715 | " " Crank..... |
| 156c | 691 | " " " " Position Screw..... |
| 190D | 691 | " " " " Set Screw..... |
| 3126 | 3633 | Guide Bar..... |
| 56752 | — | " " 3126 with 2361 and two 2362 |
| 56844 | — | " " 56752 with 337D and 3137... |
| 16781 | — | Guide Bar complete, Nos. 810D, 810E, 4723, 4897, 16780, 56844 and three 404D |
| 4854 | 3633 | Guide Bar Driving Crank with 1862 and 3131..... |
| 1862 | 3633 | Guide Bar Driving Crank Roller..... |
| 3131 | 3633 | " " " " " Cap..... |
| 3094 | 3633 | " " " " Wedge..... |
| 690E | 691 | " " " " " Screw..... |
| 4723 | 3633 | " " Lifting Bracket..... |

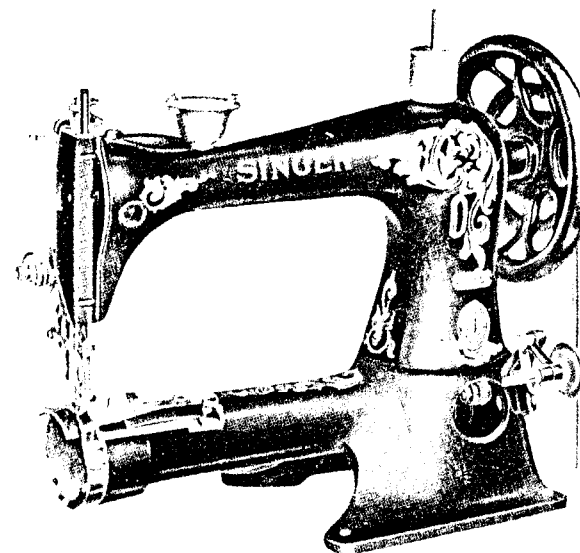
| NO. | PLATE | NAME |
|--------|-------|---|
| 404D | 692 | Guide Bar Lifting Bracket Screw..... |
| 2058 | 727 | Lifting Presser Bar..... |
| 3133 | 3632 | " " " Bracket with 641E and 1823..... |
| 641E | 691 | Lifting Presser Bar Bracket Clamping Screw..... |
| 1823 | 693 | Lifting Presser Bar Bracket Roller and Stud..... |
| 4855 | 723 | Lifting Presser Bar Lifter..... |
| 598C | 691 | " " " " Screw..... |
| 4725 | 695 | " " " Lifting Bracket..... |
| 4726 | 695 | " " " " " Guide Pin..... |
| 3100 | 727 | Lifting Presser Bar Spring..... |
| 2070 | 686 | " " " " Washer..... |
| 5816 | 728 | " " Foot..... |
| 193D | 691 | " " " Screw..... |
| 5981 | — | Loose Wheel Attachment complete, Nos. 5977 and 5993..... |
| 4264 | 727 | Needle Bar..... |
| *4898 | 3633 | " " Connecting Link with 390E... |
| 56764 | — | " " " " 4898 with 15472..... |
| 390E | 692 | Needle Bar Connecting Link Adjusting Screw..... |
| 15472 | 3633 | Needle Bar Connecting Stud with 155c... |
| 155C | 691 | " " " " Set Screw... |
| 4265 | 686 | " Clamp with 196F..... |
| 4865 | 3632 | Needle Clamp complete, Nos. 651D, 4265 and 4266..... |
| 4266 | 3632 | Needle Clamp Thread Guide..... |
| 651D | 692 | " " " " Screw..... |
| 196F | 3632 | " " " Screw..... |
| 6436 | 727 | Oil Cup with 1111E and three 6437..... |
| 1111E | 724 | " " Screw Stud..... |
| 6437 | 723 | " " Thread Eyelet..... |
| *13009 | 715 | Oscillating Rock Shaft with 11165..... |
| 13062 | — | " " " 13009 with 56812.. |
| 3052 | 678 | " " " Hinge Pin..... |
| 56812 | — | " " " " " 3 0 5 2 with 1513J..... |
| 1513J | 693 | Oscillating Rock Shaft Hinge Pin Nut... |
| 11165 | 695 | " " " Oil Pad..... |
| 13063 | 727 | " Shaft..... |
| 5999 | — | " " Crank..... |
| 6000 | 3632 | Oscillating Shaft Crank complete, Nos. 453c, 1513J, 1885 and 5999..... |

| NO. | PLATE | NAME |
|-------|-------|--|
| 2049 | 3632 | Oscillating Shaft Crank Pin..... |
| 1885 | 693 | " " " Roller with 190D, 1054c and 5968..... |
| 190D | 691 | Oscillating Shaft Crank Roller Cap Screw |
| 5968 | 3632 | " " " " " " " Washer..... |
| 1054c | 3632 | Oscillating Shaft Crank Roller Screw Stud |
| 1513J | 693 | " " " " " " " Nut..... |
| 453c | 692 | Oscillating Shaft Crank Set Screw..... |
| 262J | 692 | Pressure Regulating Thumb Screw..... |
| 14535 | 685 | Shuttle Bobbin..... |
| 8187 | 730 | " Cylinder..... |
| *8191 | — | " " 8187 with 773F and 8188 |
| 12000 | 685 | " " Hinge Pin..... |
| 12001 | 685 | " " Latch..... |
| 12002 | 685 | " " " Pin..... |
| 11854 | 730 | " " " Spring..... |
| 590D | 692 | " " " " Screw..... |
| 5752 | 685 | " Frame..... |
| *8162 | — | Shuttle Frame 5752 with 590D, 11854, 12001 and 12002..... |
| 773F | 692 | Shuttle Tension Regulating Screw..... |
| 8188 | 730 | " " Spring..... |
| 8189 | 730 | Shuttle (cylinder) 2½ in. diam., complete, Nos. 8162, 8194, 12000 and 14535.... |
| 13023 | 715 | Shuttle Driver and Feed Lifting Eccentric |
| 2022 | 723 | " " " " " " Pin..... |
| 13024 | 715 | Shuttle Race..... |
| 13025 | 717 | " " Cap..... |
| 13026 | — | Shuttle Race Cap complete, Nos. 13015, 13025 and two 240D..... |
| 13015 | 721 | Shuttle Race Cap Latch..... |
| 240D | 691 | " " " " Screw..... |
| 102D | 724 | " " " Screw..... |
| 127E | 691 | " " " Screw..... |
| 1560C | 693 | Tension Regulating Thumb Nut..... |
| 817C | 693 | " Screw Stud..... |
| 8183 | — | " " " 817c with 1560c.... |
| 448C | 691 | " " " Set Screw..... |
| 2103 | 685 | " Spring..... |
| 2105 | 686 | " Thread Guard..... |
| 5983 | 686 | " Washer (felt)..... |
| 5984 | 686 | " " (steel)..... |
| 5795 | 686 | " Wheel with 5796..... |
| *5796 | — | " " Flange..... |

| NO. | PLATE | NAME |
|-------|-------|---|
| 5797 | — | Tension complete (wheel) Nos. 2103, 5795, 8183 and two each 5983 and 5984 |
| 12296 | 686 | Thread Eyelet (side of arm) |
| 2455 | 685 | “ Retainer Disc |
| 1562r | 693 | “ “ Regulating Thumb Nut |
| 418E | 693 | “ “ Screw Stud |
| 10141 | 685 | “ “ Spring |
| 5989 | — | Thread Retainer complete, Nos. 418E, 1562r, 10141 and two 2455 |
| *8184 | — | Thread Take-up Cam |
| 5793 | 727 | “ “ “ 8184 with 446c |
| 3012 | 3636 | “ “ “ Pin |
| 446c | 691 | “ “ “ Set Screw |
| *5758 | 678 | “ “ Lever with 1819 |
| 8159 | — | “ “ “ 5758 with 1088c |
| 1088c | 3636 | “ “ “ Hinge Screw |
| 1819 | 693 | “ “ “ Roller and Stud |
| 5991 | 686 | “ “ Spring |
| 2127 | 686 | “ “ Regulator Plate |
| 233D | 691 | “ “ “ “ “ “ |
| | | Adjusting Screw |
| 13051 | 726 | Throat Plate for 13050, 13054 and 13060 |
| 742F | 692 | “ “ Screw |
| 16780 | 727 | Vibrating Presser Bar |
| 2361 | 3633 | “ “ “ Hinge Bracket |
| 2362 | 3633 | “ “ “ “ Rivet |
| 810D | 3633 | “ “ “ “ Cap Screw |
| 4897 | 3633 | “ “ “ Lifting Bell Crank |
| 810E | 3633 | “ “ “ “ “ “ |
| | | Hinge Cap Screw |
| 3137 | 3633 | Vibrating Presser Bar Spring |
| 337D | 692 | “ “ “ “ Screw |
| 5814 | 728 | “ “ Foot |
| 217F | 691 | “ “ “ Screw |
| 6053 | 3543 | Drip Pan |

LIST OF PARTS COMPLETE

FOR



MACHINE No. 43-6

FOR STITCHING THE VISORS, SWEAT BANDS, CAP BANDS AND VISOR CUSHIONS INTO THE BODIES OF CAPS. HAS GUIDES FOR VISORS, SWEAT BAND AND CAP BAND AND FOLDER FOR THE VISOR CUSHION. CYLINDER SHUTTLE, UPPER FEED.

| NO. | PLATE | NAME |
|--------|-------|---|
| *13068 | — | Arm with 159D, 180D, 4448, 4449, 4891, 4892, 6305 and four 129D |
| 2002 | 686 | Arm Dowel Pin |
| 4448 | 695 | “ Oil Tube for intermediate bearing |
| 123E | 691 | “ Screw |
| 6178 | 3543 | “ Shaft for 3011 |
| 3005 | 678 | “ “ Bushing (back) |
| 448C | 691 | “ “ “ “ Set Screw |
| *4449 | — | “ “ “ (front) |
| 144D | 691 | “ “ Screw |

| NO. | PLATE | NAME |
|--------|-------|--|
| 4743 | 3541 | Arm Side Cover |
| 286D | 692 | " " " Thumb Screw |
| 5811 | 695 | " Spool Pin and Thread Eyelet |
| 8879 | 7801 | " " " Washer (cloth) |
| 3011 | 696 | Balance Wheel (two speed) 3 in. and 5 in. pulleys, with two 448c |
| 448c | 691 | Balance Wheel Set Screw |
| 13002 | 717 | Crank Connecting Rod with 4349 and two 158E |
| *4349 | — | Crank Connecting Rod Cap |
| 158E | 691 | " " " " Screw |
| 566c | 692 | " " " " Hinge Screw |
| 1513J | 693 | " " " " " Nut |
| *13069 | — | Cylinder, 3¼ in. diam |
| 13070 | 3541 | Face Plate |
| 13071 | — | " " 13070 with 2105 |
| 13072 | — | Face Plate complete, Nos. 233D, 448c, 2108, 2127, 5797, 5989, 5991 and 13071 |
| 175D | 691 | Face Plate Screw |
| 2108 | 686 | " " Thread Guard |
| 13073 | 3541 | Feed Bar |
| 6306 | 723 | " " Connecting Link |
| 89F | 723 | " " " " Hinge Screw |
| 2361 | 3633 | " " Hinge Bracket |
| 2362 | 3633 | " " " " Rivet |
| 810D | 3633 | " " " Cap Screw |
| 24630 | 730 | " Cam with two 435c |
| 435c | 691 | " " Set Screw |
| 13074 | 3541 | " Forked Connection with 453c |
| 3093 | 723 | " " " Pin |
| 453c | 692 | " " " Set Screw |
| 4904 | 3541 | " Lever |
| *6305 | — | " " Bracket with two 620c |
| 180D | 691 | " " " " Screw (lower) |
| 159D | 691 | " " " " " (upper) |
| 6307 | 723 | " " Hinge Pin |
| 620c | 723 | " " " " Set Screw |
| 13077 | 3542 | " Point |
| 217D | 691 | " " Screw |
| 4905 | 3541 | " Regulator with 4907 and two 237D |
| 13075 | — | Feed Regulator complete, Nos. 666E, 1014D, 4905, 4959 and 13076 |
| 2049 | 3632 | Feed Regulator Pin |
| 13076 | 723 | " " Slide Block |
| 1014D | 723 | " " Thumb Screw |
| 666F | 724 | " " " " Lock Screw |

| NO. | PLATE | NAME |
|--------|-------|--|
| 4959 | 723 | Feed Regulator Thumb Screw Lock Stud (brass) |
| 4907 | 723 | Feed Regulator Thumb Screw Stop Bracket |
| 237D | 723 | Feed Regulator Thumb Screw Stop Bracket Screw |
| 4908 | 3541 | Feed Shaft |
| *4892 | — | " " Bracket (back) |
| 129D | 691 | " " " " Screw |
| *4891 | — | " " " (front) |
| 129D | 691 | " " " " Screw |
| 120167 | 5664 | Guide, for band of caps, for stitching visors and sweat bands in caps in one operation |
| 120168 | 5664 | Guide, for visors, for stitching visors and sweat bands in caps in one operation |
| 120169 | 5664 | Guide, for visors, when cushion is fitted on visor and sweat band stitched in by hand |
| 120170 | 5695 | Guide |
| 120171 | 5695 | " Block |
| 234D | 5695 | " " Screw |
| 120172 | 5695 | " Body |
| 234D | 5695 | " " Screw |
| 120173 | 5695 | " Shank |
| 120174 | 5695 | " Tension Block |
| 120175 | 5695 | " " " Holder with 120174 and two 19088 |
| 19088 | 5695 | Guide Tension Block Rivet |
| 120176 | 5695 | " " Spring with 17830 |
| 17830 | 5695 | " " " Steady Pin |
| 732D | 724 | " " Thumb Screw |
| 658D | 724 | " Thumb Screw |
| 7071 | 695 | " " " Washer |
| 120177 | — | Guide (adjustable) complete, for sweat bands, for stitching visors and sweat bands in caps in one operation, Nos. 658D, 732D, 7071, 120170 to 120173, 120175, 120176 and four 234D |
| 3126 | 3633 | Guide Bar |
| 13078 | — | Guide Bar complete, Nos. 810D, 810E, 2361, 3126, 4723, 4897, 13073, two 2362 and three 404D |
| 4854 | 3633 | Guide Bar Driving Crank with 1862 and 3131 |
| 1862 | 3633 | Guide Bar Driving Crank Roller |
| 3131 | 3633 | " " " " Cap |
| 3094 | 3633 | " " " " Wedge |

| NO. | PLATE | NAME |
|--------|-------|---|
| 690E | 691 | Guide Bar Driving Crank Wedge Screw... |
| 4723 | 3633 | " " Lifting Bracket..... |
| 404D | 692 | " " " " Screw..... |
| 335D | 724 | " Screw for 120167..... |
| 190D | 691 | " " " 120177..... |
| 185D | 724 | " " " 120168 and 120169..... |
| 7071 | 695 | " " Washer..... |
| 2058 | 727 | Lifting Presser Bar..... |
| 3133 | 3632 | " " " Bracket with 641E and 1823..... |
| 641E | 691 | Lifting Presser Bar Bracket Clamping Screw..... |
| 1823 | 693 | Lifting Presser Bar Bracket Roller and Stud..... |
| 4909 | 730 | Lifting Presser Bar Lifter..... |
| 598c | 691 | " " " " Screw..... |
| 4897 | 3633 | " " " Lifting Bell Crank |
| 810E | 3633 | " " " " " " " " |
| | | Hinge Cap Screw..... |
| 4725 | 695 | Lifting Presser Bar Lifting Bracket..... |
| 4726 | 695 | " " " " " Guide Pin..... |
| 3100 | 727 | Lifting Presser Bar Spring..... |
| 2070 | 3632 | " " " " Washer..... |
| 13079 | 3542 | " " Foot..... |
| 193D | 691 | " " " Screw..... |
| 13080 | 3541 | Needle Bar..... |
| *4898 | 3633 | " " Connecting Link with 390E... |
| 56764 | — | " " " " 4898 with 15472..... |
| 390E | 692 | Needle Bar Connecting Link Adjusting Screw..... |
| 15472 | 3633 | Needle Bar Connecting Stud with 155c... |
| 155c | 691 | " " " " Set Screw... |
| 13081 | 730 | " Clamp with 196F..... |
| 196F | 3632 | " " Screw..... |
| 13082 | — | " Plate..... |
| 13083 | — | " " Body with 120179..... |
| 691F | 724 | " " " Screw..... |
| 401E | 7801 | " " Screw..... |
| 13084 | 3542 | Needle Plate complete, Nos. 401E, 13082 and 13083..... |
| 6436 | 727 | Oil Cup with 1111E and three 6437..... |
| 1111E | 724 | " " Screw Stud..... |
| 6437 | 723 | " " Thread Eyelet..... |
| *13009 | 715 | Oscillating Rock Shaft with 11165..... |
| 13062 | — | " " " 13009 with 56812 |

| NO. | PLATE | NAME |
|-------|-------|--|
| 3052 | 678 | Oscillating Rock Shaft Hinge Pin..... |
| 56812 | — | " " " " " 3 0 5 2 with 1513J..... |
| 1513J | 693 | Oscillating Rock Shaft Hinge Pin Nut... |
| 11165 | 695 | " " " Oil Pad..... |
| 13063 | 727 | " Shaft..... |
| 5999 | — | " " Crank..... |
| 6000 | 3632 | Oscillating Shaft Crank complete, Nos. 453c, 1513J, 1885 and 5999..... |
| 2049 | 686 | Oscillating Shaft Crank Pin..... |
| 1885 | 693 | " " " Roller with 190D, 1054c and 5968..... |
| 190D | 691 | Oscillating Shaft Crank Roller Cap Screw |
| 5968 | 686 | " " " " " " |
| | | Washer..... |
| 1054c | 3632 | Oscillating Shaft Crank Roller Screw Stud |
| 1513J | 693 | " " " " " " |
| | | Nut..... |
| 453c | 692 | Oscillating Shaft Crank Set Screw..... |
| 262J | 692 | Pressure Regulating Thumb Screw..... |
| 1632c | 724 | " " " " " Lock Nut..... |
| 14535 | 685 | Shuttle Bobbin..... |
| 8187 | 730 | " Cylinder..... |
| *8194 | — | " " 8187 with 773F and 8188 |
| 12000 | 685 | " " Hinge Pin..... |
| 12001 | 685 | " " Latch..... |
| 12002 | 685 | " " Pin..... |
| 11854 | 730 | " " Spring..... |
| 590D | 692 | " " " " Screw..... |
| 5752 | 685 | " Frame..... |
| *8162 | — | " " 5752 with 590D, 11854, 12001 and 12002..... |
| 773F | 692 | Shuttle Tension Regulating Screw..... |
| 8188 | 730 | " " Spring..... |
| 8189 | 730 | Shuttle (cylinder) 2½ in. diam., complete, Nos. 8162, 8194, 12000 and 14535.... |
| 13023 | 715 | Shuttle Driver and Feed Lifting Eccentric |
| 2022 | 723 | " " " " " " |
| | | Pin..... |
| 13085 | 729 | Shuttle Race..... |
| 13086 | — | " " 13085 with 1161D, 13089 and 13090..... |
| 13087 | 729 | Shuttle Race Cap..... |
| 13088 | — | Shuttle Race Cap complete, Nos. 13015, 13087 and two 240D..... |
| 13015 | 721 | Shuttle Race Cap Latch..... |

| NO. | PLATE | NAME |
|-------|-------|--|
| 240b | 691 | Shuttle Race Cap Latch Screw |
| 102d | 724 | " " " Screw |
| 13089 | 730 | " " Thread Guard |
| 1161d | 730 | " " " " Screw |
| 13090 | 730 | " " " " Steady Pin |
| 127E | 691 | " " Screw |
| 1560c | 693 | Tension Regulating Thumb Nut |
| 817c | 693 | " Screw Stud |
| 8183 | — | " " " 817c with 1560c |
| 448c | 691 | " " " Set Screw |
| 2103 | 685 | " Spring |
| 2105 | 686 | " Thread Guard |
| 5983 | 686 | " Washer (felt) |
| 5984 | 686 | " " (steel) |
| 5795 | 686 | " Wheel with 5796 |
| *5796 | — | " Flange |
| 5797 | — | Tension complete (wheel) Nos. 2103, 5795, 8183 and two each 5983 and 5984 |
| 12296 | 686 | Thread Eyelet (side of arm) |
| 2455 | 685 | " Retaining Disc |
| 1562r | 693 | " " Regulating Thumb Nut |
| 418E | 693 | " " Screw Stud |
| 10141 | 685 | " " Spring |
| 5989 | — | Thread Retainer complete, Nos. 418E, 1562r, 10141 and two 2455 |
| *8184 | — | Thread Take-up Cam (steel) |
| 5793 | 727 | " " " 8184 with 446c |
| 3012 | 3636 | " " " Pin |
| 446c | 691 | " " " Set Screw |
| *5758 | 678 | " " Lever with 1819 |
| 8159 | — | " " " 5758 with 1088c |
| 1088c | 3636 | " " " Hinge Screw |
| 1819 | 693 | " " " Roller and Stud |
| 5991 | 686 | " " Spring |
| 2127 | 686 | " " " Regulator Plate |
| 233d | 691 | " " " " " |
| | | Adjusting Screw |
| 6053 | 3543 | Drip Pan |

BINDER

FOR 43-6 MACHINE

| NO. | PLATE | NAME |
|--------|-------|--|
| 120178 | 5664 | Binder on Shank, for visor cushion |
| 190d | 691 | " Screw |
| 7071 | 695 | " " Washer |
| 120179 | 5664 | " Stop Stud |

IRON BASE

| NO. | PLATE | NAME |
|-------|-------|--|
| 13036 | 722 | Machine Base with four each 318E, 599E and eight 6055 |
| 599E | 724 | Machine Base Bolt with 1524E, to secure base to table |
| 1524E | 724 | Machine Base Bolt Nut |
| 6055 | 730 | " " " " Washer |
| 318E | 724 | " Bolt with 1524E, to secure ma- chine to base |
| 1524E | 724 | Machine Bolt Nut |
| 6055 | 730 | " " " Washer |

ACCESSORIES

| NO. | PLATE | NAME |
|--------|-------|--|
| 599E | 724 | Machine Bolt with 1524E, to secure machine to table |
| 1524E | 724 | Machine Bolt Nut |
| 6055 | 730 | " " " Washer |
| 120342 | 5901 | Oilier (copper plated) with 120343 |
| 120343 | 5901 | " Spout, 3 1/2 in. long |
| 26026 | 5901 | Screw Driver (large) |
| 26485 | 5901 | " " (small) |
| 4822 | 5901 | Wrench for 1528, 1547 and 1549 |
| 8908 | 5901 | " " 1520 |
| 4347 | 5901 | " " 1513 and 1518 |

BOBBIN WINDER

FOR 5810

| NO. | PLATE | NAME |
|-------|-------|---|
| 13031 | 715 | Bracket |
| 145d | 691 | " Screw |
| 12169 | 715 | Frame |
| 13034 | — | Frame complete, Nos. 333d, 5960 to 5963 and 12169 |
| 32d | 691 | Frame Hinge Screw |
| 5960 | 678 | Friction Wheel (leather) |
| 5961 | 678 | " " Washer |
| 333d | 692 | " " " Screw |
| 5962 | 678 | Spindle |
| 5963 | 678 | " Flange |
| 12170 | 715 | Spring |
| 180d | 691 | " Screw |
| 13033 | — | Bobbin Winder complete, Nos. 32d, 180d, 12170, 13031 and 13034 |

BOBBIN WINDER

FOR 14535

| NO. | PLATE | NAME |
|-------|-------|--|
| 13031 | 715 | Bracket..... |
| 145D | 691 | " Screw..... |
| 12169 | 715 | Frame..... |
| 13035 | — | Frame complete, Nos. 333D, 5761, 5960, 5961, 5963 and 12169..... |
| 32D | 691 | Frame Hinge Screw..... |
| 5960 | 678 | Friction Wheel (leather)..... |
| 5961 | 678 | " " Washer..... |
| 333D | 692 | " " " Screw..... |
| 5761 | 678 | Spindle..... |
| 5963 | 678 | " Flange..... |
| 12170 | 715 | Spring..... |
| 180D | 691 | " Screw..... |
| 13032 | 715 | Bobbin Winder complete, Nos. 32D, 180D, 12170, 13031 and 13035..... |

BOBBIN WINDER(SWINGING AUTOMATIC, RIGHT HAND)
FOR 5810

| NO. | PLATE | NAME |
|--------|-------|---|
| 27540 | 7800 | Base..... |
| 27302 | 7805 | Frame..... |
| 50356D | 7801 | " Hinge Screw..... |
| 1620J | 7801 | " " " Nut..... |
| 27303 | 7801 | " Spring..... |
| 27541 | 7800 | Pulley..... |
| 27333 | 7805 | Spindle..... |
| 27323 | 7805 | Spool Pin..... |
| 27324 | 7805 | " Stand..... |
| 27325 | 7805 | Spool Stand complete, Nos. 418E, 1562J, 10141, 11241, 27323, 27324, 34358M and two each 2455 and wood screws 1 in. No. 10..... |
| 11241 | 7800 | Spool Washer (cloth)..... |
| 27334 | 7805 | Stop Latch..... |
| 35D | 7801 | " " Hinge Screw..... |
| 2455 | 685 | Tension Disc..... |
| 1562J | 693 | " Regulating Thumb Nut..... |
| 418E | 693 | " Screw Stud..... |
| 10141 | 685 | " Spring..... |
| 34358 | 730 | " Thread Guide..... |

| NO. | PLATE | NAME |
|-------|-------|--|
| 27648 | 7805 | Bobbin Winder, Nos. 35D, 1620J, 27302, 27303, 27333, 27334, 27540, 27541, 50356D and two wood screws 1 in. No. 7 |
| 27550 | — | Bobbin Winder (swinging automatic, right hand) complete, Nos. 27325 and 27648 |

BOBBIN WINDER(SWINGING AUTOMATIC, RIGHT HAND)
FOR 14535

| NO. | PLATE | NAME |
|--------|-------|---|
| 27540 | 7800 | Base..... |
| 15072 | 7801 | Bobbin Position Pin..... |
| 27527 | 7800 | Frame..... |
| 50356D | 7801 | " Hinge Screw..... |
| 1620J | 7801 | " " " Nut..... |
| 27303 | 7801 | " Spring..... |
| 27541 | 7800 | Pulley..... |
| 27330 | 7800 | Spindle with 15072..... |
| 27323 | 7805 | Spool Pin..... |
| 27324 | 7805 | " Stand..... |
| 27325 | 7805 | Spool Stand complete, Nos. 418E, 1562J, 10141, 11241, 27323, 27324, 34358M and two each 2455 and wood screws 1 in. No. 10..... |
| 11241 | 7800 | Spool Washer (cloth)..... |
| 27331 | 7800 | Stop Latch..... |
| 35D | 7801 | " " Hinge Screw..... |
| 2455 | 685 | Tension Disc..... |
| 1562J | 693 | " Regulating Thumb Nut..... |
| 418E | 693 | " Screw Stud..... |
| 10141 | 685 | " Spring..... |
| 34358 | 730 | " Thread Guide..... |
| 27649 | 7800 | Bobbin Winder, Nos. 35D, 1620J, 27303, 27330, 27331, 27527, 27540, 27541, 50356D and two wood screws 1 in. No. 7 |
| 27551 | — | Bobbin Winder (swinging automatic, right hand) complete, Nos. 27325 and 27649 |

BOBBIN WINDER(SWINGING AUTOMATIC, RIGHT HAND)
FOR FLAT OR ROUND BELT, FOR 14535.

| NO. | PLATE | NAME |
|-------|-------|--|
| 41439 | 7804 | Base with 458C, 27916 and two 28084... |
| 41398 | 3583 | Bobbin Carrier Key..... |

BOBBIN WINDERS

| NO. | PLATE | NAME |
|-------|-------|--|
| 27916 | 3583 | Brake (leather) |
| 28084 | 3583 | " Rivet |
| 41440 | 3581 | Frame |
| 41441 | 3581 | " Hinge Pin |
| 458c | 3583 | " " " Set Screw |
| 4784 | 3583 | " Oil Pad |
| 41442 | 3581 | " Spring |
| 41443 | 3581 | Pulley with 155c |
| 155c | 3583 | " Set Screw |
| 41444 | 7804 | Spindle with 41398 |
| 41445 | 7804 | Stop Latch |
| 41446 | 7804 | " " Hinge Pin |
| 2269 | 686 | " " Pin |
| 41447 | 3581 | Tripping Arm with 176D |
| 176D | 3583 | " " Clamping Screw |
| 41448 | 7804 | Bobbin Winder, Nos. 2269, 41439 to 41447, two 4784 and three wood screws 1 in. No. 7 |

THREAD UNWINDER PARTS

| | | |
|-------|------|---|
| 27555 | 3582 | Spool Pin |
| 41450 | 3582 | " Rest |
| 41451 | — | " " 41450 with 138B and 27555 |
| 138B | 3583 | " " Set Screw |
| 27557 | 3582 | " Stand with 138B |
| 41514 | 3582 | " Weight, 4 in. diam., with 41515 |
| 41515 | 3583 | " " Centre Pin |
| 2102 | 3583 | Tension Disc |
| 1560c | 3583 | " Regulating Thumb Nut |
| 828c | 7801 | " Screw Stud |
| 2103 | 3583 | " Spring |
| 5769 | 3583 | " Thread Eyelet |
| 17547 | 7801 | " " Guard |
| 60608 | 3582 | Thread Guard |
| 27560 | 3582 | " " Rod, 26 in. long |
| 138B | 3583 | " " Set Screw |
| 330D | 3583 | " " Set Screw |
| 60609 | — | Thread Guard complete, Nos. 330D, 828c, 1560c, 2103, 5769, 17547, 60608 and two 2102 |
| 41454 | 3582 | Thread Unwinder complete, for one large spool, Nos. 27557, 27560, 41451, 41514, 60609 and three wood screws 1¼ in. No. 12 |
| 41449 | — | Bobbin Winder (swinging automatic, right hand) complete, Nos. 41448 and 41454 |

KNEE LIFTER PARTS

FOR 43-1 TO 43-4 MACHINES

| NO. | PLATE | NAME |
|-------|-------|--|
| 7170 | 3543 | Lifting Lever |
| 802D | 691 | " " Hinge Screw |
| 16659 | 3543 | " " Spring |
| 6703 | 3543 | Pitman, length 14½ in. |
| 2763 | 3543 | Rock Shaft |
| 6334 | 3543 | " " Hanger with two wood screws 1 in. No. 10 |
| 16646 | 3543 | Rock Shaft Knee Arm |
| 16647 | — | Rock Shaft Knee Arm complete, Nos. 2766, 2767 and 16646 |
| 2766 | 3543 | Rock Shaft Knee Arm Hub with 356c |
| 356c | 693 | " " " " " Set Screw |
| 2767 | 3543 | " " " " " Plate with 356c |
| 356c | 693 | " " " " " Set Screw |
| 6337 | 3543 | " " Lifting Bracket with two 356c |
| 6338 | 3543 | " " " " " Hook |
| 356c | 693 | " " " " " " Set Screw |
| 356c | 693 | Rock Shaft Lifting Bracket Set Screw |
| 2770 | 3543 | " " Stop Dog with 356c |
| 356c | 693 | " " " " " Set Screw |
| 6339 | 3543 | Rock Shaft complete, Nos. 2763, 2770, 6337, 6338, 16647 and two 6334 |
| 13037 | — | Knee Lifter complete, Nos. 802D, 6339, 6703, 7170 and 16659 |

KNEE LIFTER PARTS

FOR 43-5 MACHINE

| NO. | PLATE | NAME |
|-------|-------|--|
| 16648 | 3543 | Lifting Lever with 448c |
| 802D | 691 | " " Hinge Screw |
| 4727 | 695 | " " Pin |
| 448c | 691 | " " " " " Set Screw |
| 16659 | 3543 | " " Spring |
| 4725 | 695 | " Presser Bar Lifting Bracket |
| 4726 | 695 | " " " " " " Guide Pin |
| 6703 | 3543 | Pitman, length 14½ in. |
| 2763 | 3543 | Rock Shaft |
| 6334 | 3543 | " " Hanger with two wood screws 1 in. No. 10 |

KNEE LIFTER PARTS

| NO. | PLATE | NAME |
|-------|-------|--|
| 16646 | 3543 | Rock Shaft Knee Arm..... |
| 16647 | — | Rock Shaft Knee Arm complete, Nos. 2766, 2767 and 16646..... |
| 2766 | 3543 | Rock Shaft Knee Arm Hub with 356c.... |
| 356c | 693 | " " " " " Set Screw.... |
| 2767 | 3543 | " " " " Plate with 356c..... |
| 356c | 693 | " " " " Set Screw..... |
| 6337 | 3543 | " " " " Lifting Bracket with two 356c..... |
| 6338 | 3543 | " " " " Hook..... |
| 356c | 693 | " " " " " " Set Screw..... |
| 356c | 693 | Rock Shaft Lifting Bracket Set Screw.... |
| 2770 | 3543 | " " " " Stop Dog with 356c..... |
| 356c | 693 | " " " " Set Screw..... |
| 6339 | 3543 | Rock Shaft complete, Nos. 2763, 2770, 6337, 6338, 16647 and two 6334..... |
| 13098 | — | Knee Lifter complete, Nos. 802D, 4725 to 4727, 6339, 6703, 16648 and 16659 |

KNEE LIFTER PARTS

FOR 43-6 MACHINE

| NO. | PLATE | NAME |
|-------|-------|--|
| 16641 | 3543 | Lifting Lever with 448c..... |
| 1064D | 724 | " " Hinge Screw..... |
| 4896 | 3541 | " " Hook..... |
| 448c | 691 | " " " " Set Screw..... |
| 16659 | 3543 | " " Spring..... |
| 4725 | 695 | " Presser Bar Lifting Bracket..... |
| 4726 | 695 | " " " " " " Guide Pin..... |
| 6343 | 3543 | Pitman..... |
| 2763 | 3543 | Rock Shaft..... |
| 6334 | 3543 | " " Hanger with two wood screws 1 in. No. 10..... |
| 16646 | 3543 | Rock Shaft Knee Arm..... |
| 16647 | — | Rock Shaft Knee Arm complete, Nos. 2766, 2767 and 16646..... |
| 2766 | 3543 | Rock Shaft Knee Arm Hub with 356c.... |
| 356c | 693 | " " " " " " Set Screw.... |
| 2767 | 3543 | " " " " Plate with 356c..... |
| 356c | 693 | " " " " Set Screw..... |
| 6337 | 3543 | " " " " Lifting Bracket with two 356c..... |
| 6338 | 3543 | " " " " Hook..... |
| 356c | 693 | " " " " " " Set Screw..... |

KNEE LIFTER PARTS

| NO. | PLATE | NAME |
|-------|-------|---|
| 356c | 693 | Rock Shaft Lifting Bracket Set Screw ... |
| 2770 | 3543 | " " " " Stop Dog with 356c..... |
| 356c | 693 | " " " " " " Set Screw..... |
| 6339 | 3543 | Rock Shaft complete, Nos. 2763, 2770, 6337, 6338, 16647 and two 6334..... |
| 16645 | — | Knee Lifter complete, Nos. 1064D, 4725, 4726, 4896, 6339, 6343, 16641 and 16659 |

STAND

ROCKING TREADLE

| NO. | PLATE | NAME |
|-------|-------|--|
| 25133 | 381 | Band Wheel (two speed) 10 in. and 12 in. diam., with 2117 and 25010..... |
| 25010 | 381 | Band Wheel Crank..... |
| 2117 | 695 | " " " " Pin..... |
| 297c | 692 | " " " " Screw Centre..... |
| 46629 | — | " " " " " " 297cwith 1507J..... |
| 1507J | 693 | Band Wheel Crank Screw Centre Nut... |
| 25176 | — | Belt, size $\frac{5}{8}$ in., length 68 in., with 25029 |
| 25029 | 695 | " Hook..... |
| 25368 | 381 | Brace with three 46629..... |
| 506E | 692 | " Bolt with 1510E..... |
| 1510E | 693 | " " Nut..... |
| 25065 | 381 | Leg..... |
| 25123 | — | Pitman Adjusting Block..... |
| 558E | 693 | " " " " Screw..... |
| 1570E | 693 | " " " " Nut..... |
| 25075 | 695 | " " " " Washer..... |
| 25074 | 381 | Pitman (adjustable) complete, with two each 558E, 1570E, 25075 and 25123.... |
| 7958 | 695 | Pitman Pin..... |
| 11742 | 695 | " Washer..... |
| 25077 | 381 | Table Support..... |
| 1059E | 724 | " " Bolt with 1510E..... |
| 1510E | 693 | " " " " Nut..... |
| 25082 | 381 | Treadle..... |
| 297c | 692 | " Screw Centre..... |
| 1507J | 693 | " " " " Nut..... |
| 46629 | — | " " " " 297c with 1507J... |
| 25086 | 381 | Wrench for 1507 and 1510..... |
| 25246 | — | Stand (iron work) complete, Nos. 1059E, 7958, 11742, 25074, 25077, 25082, 25086, 25133, 25368, two 25065 and four 506E |

OBSOLETE PARTS

| NO. | PLATE | NAME |
|-------|-------|--|
| 13003 | 719 | Face Plate for 600 and 2111, for 43-1 and 43-2 Machines |
| 13040 | 725 | Feed Dog (double) for 13042, for 43-3 Machine |
| 13021 | 725 | Feed Dog, for leather, 12 teeth, for 43-4 Machine |
| 13010 | 717 | Oscillating Shaft for 43-1 and 43-2 Machines |
| 12093 | 685 | Shuttle Cylinder |
| 56514 | — | “ “ 12093 with 773r and 12095 |
| 12095 | 685 | Shuttle Tension Spring |
| 5751 | 685 | Shuttle (cylinder) 2½ in. diam., complete, Nos. 8162, 12000, 14535 and 56514, use 8189 |
| 13011 | 721 | Shuttle Driver and Feed Cam for 43-1 and 43-2 Machines |
| 13042 | 725 | Throat Plate for 13040 |
| 13027 | 725 | “ “ “ 13021 |

NUMERICAL LIST OF PARTS

NUMERICAL LIST OF PARTS

| NO. | PLATE | NAME |
|------|-------|---|
| 32D | 691 | Bobbin Winder Frame Hinge Screw for 13032 and 13033..... |
| 35D | 7801 | Bobbin Winder Stop Latch Hinge Screw for 27648 and 27649..... |
| 89F | 723 | Feed Bar Connecting Link Hinge Screw for 43-6 Machine..... |
| 102D | 724 | Shuttle Race Ring Cap Screw for 43-1 and 43-2 Machines..... |
| 102D | 724 | Shuttle Race Cap Screw for 43-3 to 43-6 Machines..... |
| 123E | 691 | Arm Screw..... |
| 127E | 691 | Shuttle Race Screw for 43-3 to 43-6 Machines..... |
| 129D | 691 | Feed Shaft Bracket (back) Screw for 13068 |
| 129D | 691 | “ “ “ (front) Screw for 13068 |
| 136F | 691 | Driving Flange Latch Hinge Screw for 5993..... |
| 138B | 3583 | Thread Unwinder Spool Rest Set Screw for 41451..... |
| 138B | 3583 | Thread Unwinder Thread Guard Rod Set Screw for 27557..... |
| 144D | 691 | Arm Shaft Screw..... |
| 145D | 691 | Bobbin Winder Bracket Screw for 13031.. |
| 145D | 691 | Shuttle Race Ring Screw for 43-1 and 43-2 Machines..... |
| 155C | 3583 | Bobbin Winder Pulley Set Screw for 41443 |
| 155C | 691 | Needle Bar Connecting Stud Set Screw for 2052, 3147 and 15472..... |
| 156C | 691 | Feed Rock Shaft Crank Position Screw for 43-1 to 43-5 Machines..... |
| 158E | 691 | Crank Connecting Rod Cap Screw for 13002..... |
| 159D | 691 | Feed Lever Bracket Screw (upper) for 13068..... |
| 164D | 691 | Face Plate Screw for 43-1 to 43-4 Machines..... |
| 175D | 691 | Face Plate Screw for 43-5 and 43-6 Machines..... |
| 175E | 691 | Needle Bar Cam Clamping Screw for 5457..... |
| 176D | 3583 | Bobbin Winder Tripping Arm Clamping Screw for 41447..... |
| 176D | 691 | Roller Arm Lock Spring Screw for 5964.. |

NUMERICAL LIST OF PARTS

| NO. | PLATE | NAME |
|------|-------|---|
| 180D | 691 | Bobbin Winder Spring Screw for 13032 and 13033..... |
| 180D | 691 | Feed Lever Bracket Screw (lower) for 13068..... |
| 180D | 691 | Lifting Lever Hinge Bracket Screw for 43-3 Machine..... |
| 185D | 724 | Guide Screw for 120168 and 120169..... |
| 190D | 691 | Binder Screw for 120178..... |
| 190D | 691 | Feed Rock Shaft Crank Set Screw for 43-1 to 43-5 Machines..... |
| 190D | 691 | Guide Screw for 120177..... |
| 190D | 691 | Oscillating Shaft Crank Roller Cap Screw for 1885..... |
| 190D | 691 | Presser Foot Screw for 43-1, 43-2 and 43-4 Machines..... |
| 190D | 691 | Roller Presser Screw for 43-1 and 43-4 Machines..... |
| 190D | 691 | Vibrating Presser Guide Bracket Screw for 43-3 Machine..... |
| 191F | 691 | Vibrating Presser Foot Screw for 5886.. |
| 193D | 691 | Lifting Presser Foot Screw for 43-5 and 43-6 Machines..... |
| 196F | 3632 | Needle Clamp Screw for 4265 and 13081 |
| 207D | 691 | Lifting Lever Hinge Stud Screw for 43-3 Machine..... |
| 212D | 691 | Vibrating Presser Hinge Bracket Cap Screw for 43-3 Machine..... |
| 217D | 691 | Feed Point Screw for 43-6 Machine..... |
| 217F | 691 | Vibrating Presser Foot Screw for 43-5 Machine..... |
| 233D | 691 | Face Plate Thread Guard Screw for 8179 and 8180..... |
| 233D | 691 | Thread Take-up Spring Regulator Plate Adjusting Screw for 8178 to 8180, 8182 and 13072..... |
| 233D | 691 | Vibrating Presser Spring Screw for 43-3 Machine..... |
| 234D | 5695 | Guide Block Screw for 120177..... |
| 234D | 5695 | " Body Screw for 120177..... |
| 237D | 723 | Feed Regulator Thumb Screw Stop Bracket Screw for 4905..... |
| 240D | 691 | Cloth Plate Slide Spring Screw for 13048 |
| 240D | 691 | Shuttle Race Ring Cap Latch Screw for 13014..... |
| 240D | 691 | Shuttle Race Cap Latch Screw for 13026, 13088 and 13095..... |
| 262J | 692 | Pressure Regulating Thumb Screw..... |

NUMERICAL LIST OF PARTS

| NO. | PLATE | NAME |
|------|-------|---|
| 286D | 692 | Arm Side Cover Thumb Screw..... |
| 290E | 692 | Lifting Presser Bar Screw Bushing for 43-3 Machine..... |
| 290E | 692 | Needle Bar Screw Bushing for 43-1 to 43-4 Machines..... |
| 290E | 692 | Presser Bar Screw Bushing for 43-1, 43-2 and 43-4 Machines..... |
| 297C | 692 | Band Wheel Crank Screw Centre for 46629 |
| 297C | 692 | Treadle Screw Centre for 46629..... |
| 316F | 692 | Roller Arm Screw Centre for 5964... |
| 318E | 724 | Machine Bolt with 1524E, to secure machine to base, for 13036..... |
| 330D | 692 | Driving Flange Latch Spring Screw for 5993..... |
| 330D | 3583 | Thread Unwinder Thread Guard Set Screw for 60609..... |
| 333D | 692 | Bobbin Winder Friction Wheel Washer Screw for 13034 and 13035..... |
| 335D | 724 | Guide Screw for 120167..... |
| 337D | 692 | Vibrating Presser Bar Spring Screw for 56844..... |
| 356C | 693 | Rock Shaft Knee Arm Hub Set Screw for 2766..... |
| 356C | 693 | Rock Shaft Knee Plate Set Screw for 2767 |
| 356C | 693 | Rock Shaft Lifting Bracket Hook Set Screw for 6337..... |
| 356C | 693 | Rock Shaft Lifting Bracket Set Screw for 6337..... |
| 356C | 693 | Rock Shaft Stop Dog Set Screw for 2770 |
| 375C | 692 | Feed Connecting Link Hinge Screw for 43-1 to 43-5 Machines..... |
| 375C | 692 | Feed Forked Connection Hinge Screw for 43-1 to 43-5 Machines..... |
| 377C | 692 | Needle Bar Connecting Link Hinge Screw for 43-2 to 43-4 Machines..... |
| 389F | 724 | Cloth Plate Screw for 13049 and 13053 |
| 390E | 692 | Needle Bar Connecting Link Adjusting Screw for 4898..... |
| 401E | 7801 | Needle Plate Screw for 13084..... |
| 404D | 692 | Guide Bar Lifting Bracket Screw for 13078 and 16781..... |
| 418E | 693 | Bobbin Winder Tension Screw Stud for 27325..... |
| 418E | 693 | Thread Retaining Screw Stud for 5989.. |
| 435C | 691 | Driving Flange Set Screw for 5978..... |
| 435C | 691 | Feed Cam Set Screw for 24630..... |
| 440F | 691 | Roller Arm Adjusting Screw for 5964.... |

NUMERICAL LIST OF PARTS

| NO. | PLATE | NAME |
|------|-------|---|
| 446c | 691 | Feed Cam Set Screw for 3032 and 13018 |
| 446c | 691 | Thread Take-up Cam Set Screw for 5757, 5793, 5952, 13017 and 13043..... |
| 448c | 691 | Arm Shaft Bushing (back) Set Screw.... |
| 448c | 691 | Balance Wheel Set Screw for 3011..... |
| 448c | 691 | Lifting Lever Hook Set Screw for 10041 |
| 448c | 691 | " " Pin Set Screw for 10048.... |
| 448c | 691 | Tension Screw Stud Set Screw for 8178 to 8180, 8182 and 13072..... |
| 453c | 692 | Needle Bar Cam Roller and Stud Set Screw for 5952..... |
| 453c | 692 | Feed Forked Connection Set Screw for 13074..... |
| 453c | 692 | Oscillating Shaft Crank Set Screw for 5967 and 6000..... |
| 453c | 692 | Presser Bar Lifting Bracket Set Screw for 5608 and 5827..... |
| 453c | 692 | Lifting Presser Bar Lifting Bracket Set Screw for 5827..... |
| 453c | 692 | Vibrating Presser Hinge Bracket Set Screw for 5830..... |
| 458c | 3583 | Bobbin Winder Frame Hinge Pin Set Screw for 41439..... |
| 506E | 692 | Brace Bolt with 1510E, for 25246..... |
| 558E | 693 | Pitman Adjusting Screw for 25074..... |
| 566c | 692 | Crank Connecting Rod Hinge Screw.... |
| 590D | 692 | Shuttle Cylinder Latch Spring Screw for 8162..... |
| 591F | 692 | Shuttle Tension Regulating Screw for 5784..... |
| 592E | 692 | Shuttle Bobbin Case Latch Stop Screw for 5784..... |
| 598c | 691 | Lifting Presser Bar Lifter Screw for 43-5 and 43-6 Machines..... |
| 599E | 724 | Machine Base Bolt with 1524E, to secure base to table, for 13036..... |
| 599E | 724 | Machine Bolt with 1524E, to secure machine to table (Accessories)..... |
| 620c | 723 | Feed Lever Hinge Pin Set Screw for 6305 |
| 634D | 692 | Roller Screw for 1875..... |
| 641E | 691 | Lifting Presser Bar Bracket Clamping Screw for 3133..... |
| 647c | 724 | Needle Bar Cam Guide Screw for 43-1 Machine..... |
| 651D | 692 | Needle Clamp Thread Guide Screw for 4803 and 4865..... |
| 658D | 724 | Guide Thumb Screw for 120177..... |

NUMERICAL LIST OF PARTS

| NO. | PLATE | NAME |
|-------|-------|---|
| 666F | 724 | Feed Regulator Thumb Screw Lock Screw for 13075..... |
| 689c | 691 | Presser Bar Lifter Screw for 43-1, 43-2 and 43-4 Machines..... |
| 6S9c | 691 | Lifting Presser Bar Lifter Screw for 43-3 Machine..... |
| 690E | 691 | Guide Bar Driving Crank Wedge Screw for 43-5 and 43-6 Machines..... |
| 691F | 724 | Needle Plate Body Screw for 43-6 Machine |
| 732D | 724 | Guide Tension Thumb Screw for 120177 |
| 742F | 692 | Throat Plate Screw for 43-1 to 43-5 Machines..... |
| 773F | 692 | Shuttle Tension Regulating Screw for 8194 and 56514..... |
| 802D | 691 | Lifting Lever Hinge Screw for 13037 and 13098..... |
| 805c | 691 | Feed Dog Screw for 43-1 to 43-5 Machines |
| 808F | 691 | Needle Clamp Screw for 4803..... |
| 810D | 3633 | Feed Bar Hinge Cap Screw for 13078.... |
| 810D | 3633 | Vibrating Presser Bar Hinge Cap Screw for 16781..... |
| 810E | 3633 | Vibrating Presser Bar Lifting Bell Crank Hinge Cap Screw for 16781..... |
| 810E | 3633 | Lifting Presser Bar Lifting Bell Crank Hinge Cap Screw for 13078..... |
| 817c | 693 | Tension Screw Stud for 8183..... |
| 818D | 692 | Feed Regulator Thumb Screw for 43-1 to 43-5 Machines..... |
| 828c | 7801 | Thread Unwinder Tension Screw Stud for 60609..... |
| 902E | 3646 | Lifting Cam Screw for 13043..... |
| 1014D | 723 | Feed Regulator Thumb Screw for 13075 |
| 1054c | 3632 | Oscillating Shaft Crank Roller Screw Stud for 1885..... |
| 1059E | 724 | Table Support Bolt with 1510E, for 25246 |
| 1064D | 724 | Lifting Lever Hinge Screw for 16645..... |
| 1068D | 3646 | " " Adjusting Screw for 5825.... |
| 108Sc | 3636 | Thread Take-up Lever Hinge Screw for 8159, 8161 and 43-3 Machine..... |
| 1107c | 724 | Cloth Plate Bracket Set Screw for 13046 and 13052..... |
| 1111E | 724 | Oil Cup Screw Stud for 6436..... |
| 1128E | 3632 | Feed Regulator Hinge Screw for 43-1 to 43-5 Machines..... |
| 1161D | 730 | Shuttle Race Thread Guard Screw for 13086..... |

| NO. | PLATE | NAME |
|-------|-------|---|
| 1507J | 693 | Band Wheel Crank Screw Centre Nut for 46629..... |
| 1507J | 693 | Treadle Screw Centre Nut for 46629..... |
| 1510E | 693 | Brace Bolt Nut for 506..... |
| 1510E | 693 | Table Support Bolt Nut for 1059..... |
| 1513J | 693 | Crank Connecting Rod Hinge Screw Nut |
| 1513J | 693 | Oscillating Rock Shaft Hinge Pin Nut for 56812..... |
| 1513J | 693 | Oscillating Shaft Crank Roller Screw Stud Nut for 5967 and 6000..... |
| 1518E | 693 | Feed Connecting Link Hinge Screw Nut for 43-1 to 43-5 Machines..... |
| 1518E | 693 | Feed Forked Connection Hinge Screw Nut for 43-1 to 43-5 Machines..... |
| 1518E | 693 | Needle Bar Connecting Link Hinge Screw Nut for 43-2 to 43-4 Machines..... |
| 1520E | 693 | Presser Bar Lifter Screw Nut for 43-1, 43-2 and 43-4 Machines..... |
| 1520E | 693 | Lifting Presser Bar Lifter Screw Nut for 43-3 Machine..... |
| 1524E | 724 | Machine Base Bolt Nut for 599..... |
| 1524E | 724 | " Bolt Nut for 318 and 599..... |
| 1528J | 693 | Roller Screw Nut for 1875..... |
| 1547J | 693 | " Arm Adjusting Screw Nut for 5964 |
| 1547J | 693 | " " Screw Centre Nut for 5964... |
| 1549J | 693 | " " Lock Spring Screw Nut for 5964..... |
| 1560c | 693 | Tension Regulating Thumb Nut for 8183 |
| 1560c | 3583 | Thread Unwinder Tension Regulating Thumb Nut for 60609..... |
| 1562J | 693 | Bobbin Winder Tension Regulating Thumb Nut for 27325..... |
| 1562J | 693 | Thread Retaining Regulating Thumb Nut for 5989..... |
| 1570E | 693 | Pitman Adjusting Screw Nut for 25074 |
| 1620J | 7801 | Bobbin Winder Frame Hinge Screw Nut for 27648 and 27649..... |
| 1632c | 724 | Pressure Regulating Thumb Screw Lock Nut for 43-6 Machine..... |
| 1819 | 693 | Thread Take-up Lever Roller and Stud for 5758, 5954 and 13041..... |
| 1823 | 693 | Lifting Presser Bar Bracket Roller and Stud for 3133..... |
| 1860 | 693 | Needle Bar Cam Roller and Stud for 43-1 Machine..... |
| 1862 | 3633 | Guide Bar Driving Crank Roller for 4854 |

| NO. | PLATE | NAME |
|------|-------|---|
| 1875 | 723 | Roller, 1½ in. diam., with 634b and 1528J, for 5964..... |
| 1885 | 693 | Oscillating Shaft Crank Roller with 190D, 1054c and 5968, for 5967 and 6000.... |
| 2002 | 686 | Arm Dowel Pin..... |
| 2022 | 723 | Shuttle Driver and Feed Lifting Cam Pin for 43-1 and 43-2 Machines..... |
| 2022 | 723 | Shuttle Driver and Feed Lifting Eccentric Pin for 43-3 to 43-6 Machines..... |
| 2049 | 3632 | Feed Regulator Pin for 43-6 Machine.... |
| 2049 | 686 | Oscillating Shaft Crank Pin..... |
| 2052 | 723 | Needle Bar Connecting Stud with 155c, for 56773..... |
| 2058 | 727 | Lifting Presser Bar for 43-5 and 43-6 Machines..... |
| 2070 | 686 | Presser Bar Spring Washer for 43-1, 43-2 and 43-4 Machines..... |
| 2070 | 686 | Lifting Presser Bar Spring Washer for 43-3, 43-5 and 43-6 Machines..... |
| 2102 | 3583 | Thread Unwinder Tension Disc for 60609 |
| 2103 | 3583 | " " " Spring for 60609..... |
| 2103 | 685 | Tension Spring for 5797..... |
| 2105 | 686 | " Thread Guard for 8173, 8174, 8177, 8181 and 13071..... |
| 2107 | 686 | Face Plate Thread Guard for 8179 and 8180..... |
| 2108 | 3636 | Face Plate Thread Guard for 8178 and 13072..... |
| 2117 | 695 | Band Wheel Crank Pin for 25133..... |
| 2127 | 686 | Thread Take-up Spring Regulator Plate for 8178 to 8180, 8182 and 13072..... |
| 2205 | 695 | Roller Arm Lock Spring for 5964..... |
| 2206 | 723 | " " Bracket for 5964..... |
| 2269 | 686 | Bobbin Winder Stop Latch Pin for 41448 |
| 2269 | 686 | Vibrating Presser Stop Pin for 43-3 Machine..... |
| 2361 | 3633 | Feed Bar Hinge Bracket for 13078..... |
| 2361 | 3633 | Vibrating Presser Bar Hinge Bracket for 56752..... |
| 2362 | 3633 | Feed Bar Hinge Bracket Rivet for 13078 |
| 2362 | 3633 | Vibrating Presser Bar Hinge Bracket Rivet for 56752..... |
| 2455 | 685 | Bobbin Winder Tension Disc for 27325 |
| 2455 | 685 | Thread Retaining Disc for 5989..... |
| 2653 | 3646 | Lifting Lever Adjusting Screw Head Rivet for 5825..... |

NUMERICAL LIST OF PARTS

| NO. | PLATE | NAME |
|-------|-------|--|
| 2763 | 3543 | Rock Shaft for 6339..... |
| 2766 | 3543 | " " Knee Arm Hub with 356c, for 16647..... |
| 2767 | 3543 | Rock Shaft Knee Plate with 356c, for 16647..... |
| 2770 | 3543 | Rock Shaft Stop Dog with 356c, for 6339 |
| 3005 | 678 | Arm Shaft Bushing (back)..... |
| 3011 | 696 | Balance Wheel (two speed) 3 in. and 5 in. pulleys, with two 448c..... |
| 3012 | 3636 | Thread Take-up Cam Pin..... |
| 3032 | 678 | Feed Cam with 446c, for 43-2 to 43-5 Machines..... |
| 3033 | 3632 | Feed Connecting Link for 43-1 to 43-5 Machines..... |
| 3039 | 3632 | Feed Regulator for 43-1 to 43-5 Machines |
| *3045 | 681 | Needle Bar Connecting Link for 56773 and 56815..... |
| 3052 | 678 | Oscillating Rock Shaft Hinge Pin for 56812 |
| 3054 | 678 | Presser Bar for 43-1, 43-2 and 43-4 Ma- chines..... |
| 3056 | 678 | Lifting Presser Bar Spring for 43-3 Machine..... |
| 3056 | 678 | Presser Bar Spring for 43-2 and 43-4 Machines..... |
| 3093 | 723 | Feed Forked Connection Pin for 43-0 Machine..... |
| 3094 | 3633 | Guide Bar Driving Crank Wedge for 43-5 and 43-6 Machines..... |
| 3100 | 727 | Lifting Presser Bar Spring for 43-5 and 43-6 Machines..... |
| 3126 | 3633 | Guide Bar for 13078 and 56752..... |
| 3131 | 3633 | " " Driving Crank Roller Cap for 4854..... |
| 3133 | 3632 | Lifting Presser Bar Bracket with 641E and 1823, for 43-5 and 43-6 Machines..... |
| 3137 | 3633 | Vibrating Presser Bar Spring for 50844.. |
| 3146 | 686 | Lifting Lever Hinge Stud Screw Washer for 43-3 Machine..... |
| 3147 | 3636 | Needle Bar Connecting Stud with 155c, for 56815..... |
| 3286 | 723 | Cloth Plate Slide Spring for 13048..... |
| 4264 | 727 | Needle Bar for 43-5 Machine..... |
| 4265 | 686 | " Clamp with 196F, for 4865..... |
| 4266 | 3632 | " " Thread Guide for 4865.... |
| 4288 | 678 | Arm Side Cover for 43-1 to 43-5 Machines |
| 4347 | 5901 | Wrench for 1513 and 1518 (Accessories).. |
| *4349 | — | Crank Connecting Rod Cap for 13002.... |

NUMERICAL LIST OF PARTS

| NO. | PLATE | NAME |
|-------|-------|---|
| 4448 | 695 | Arm Oil Tube for intermediate bearing for 13019, 13039, 13044, 13055 and 13068..... |
| *4449 | — | Arm Shaft Bushing (front) for 13019, 13039, 13044, 13055 and 13068..... |
| 4723 | 3633 | Guide Bar Lifting Bracket for 13078 and 16781..... |
| 4725 | 695 | Lifting Presser Bar Lifting Bracket for 13098 and 16645..... |
| 4726 | 695 | Lifting Presser Bar Lifting Bracket Guide Pin for 13098 and 16645..... |
| 4727 | 695 | Lifting Lever Pin for 13098..... |
| 4743 | 3541 | Arm Side Cover for 43-6 Machine..... |
| 4784 | 3583 | Bobbin Winder Frame Oil Pad for 41448 |
| 4802 | 686 | Needle Clamp Thread Guide for 4803... |
| 4803 | 686 | Needle Clamp complete for 43-1 to 43-4 Machines, Nos. 651D, 808F and 4802.. |
| 4810 | 723 | Lifting Lever Hinge Stud for 5836..... |
| 4822 | 5901 | Wrench for 1528, 1547 and 1549 (Acces- sories)..... |
| 4854 | 3633 | Guide Bar Driving Crank with 1862 and 3131, for 43-5 and 43-6 Machines..... |
| 4855 | 723 | Lifting Presser Bar Lifter for 43-5 Ma- chine..... |
| 4865 | 3632 | Needle Clamp complete for 43-5 Machine, Nos. 651D, 4265 and 4266..... |
| *4891 | — | Feed Shaft Bracket (front) for 13068..... |
| *4892 | — | " " " (back) for 13068..... |
| 4896 | 3541 | Lifting Lever Hook for 16645..... |
| 4897 | 3633 | Vibrating Presser Bar Lifting Bell Crank for 16781..... |
| 4897 | 3633 | Lifting Presser Bar Lifting Bell Crank for 13078..... |
| *4898 | 3633 | Needle Bar Connecting Link with 390E, for 56764..... |
| 4904 | 3541 | Feed Lever for 43-6 Machine..... |
| 4905 | 3541 | " Regulator with 4907 and two 237D, for 13075..... |
| 4907 | 723 | Feed Regulator Thumb Screw Stop Bracket for 4905..... |
| 4908 | 3541 | Feed Shaft for 43-6 Machine..... |
| 4909 | 730 | Lifting Presser Bar Lifter for 43-6 Ma- chine..... |
| 4959 | 723 | Feed Regulator Thumb Screw Lock Stud (brass) for 13075..... |
| 5457 | 681 | Needle Bar Cam with two 175E, for 43-1 Machine..... |

| NO. | PLATE | NAME |
|----------------------------|-------|--|
| 5458 | 681 | Needle Bar Cam Guide for 43-1 Machine. |
| 5465 | 678 | " " for 43-1 to 43-4 Machines... |
| 5608 | 727 | Presser Bar Lifting Bracket with 453c, for 43-2 and 43-4 Machines..... |
| 5751 | 685 | Shuttle Cylinder, 2½ in. diam., complete, Nos. 8162, 12000, 14535 and 56514, obsolete, use 8189..... |
| 5752 | 685 | Shuttle Frame for 8162..... |
| 5757 | 678 | Thread Take-up Cam 8185 with 440c, for 43-4 Machine..... |
| *5758 | 678 | Thread Take-up Lever with 1819, for 8159 |
| 5761 | 678 | Bobbin Winder Spindle for 13035..... |
| 5769 | 3583 | Thread Unwinder Tension Thread Eyelet for 60609..... |
| 5783 | — | Shuttle, 2½ in. diam., for 43-1 and 43-2 Machines, Nos. 5784, 5810 and 5934.. |
| 5784 | 684 | Shuttle Bobbin Case complete for 5783, Nos. 591F, 592E, 5785, 5789, 5838, 5933 and 5935..... |
| 5785 | — | Shuttle Bobbin Case Hinge for 5784, Nos. 5786 to 5788..... |
| Nos. 5786 to 5788 for 5785 | | |
| 5786 | 684 | Shuttle Bobbin Case Latch..... |
| 5787 | 684 | " " " " Lever..... |
| 5788 | 684 | " " " " " Fulcrum Pin..... |
| 5789 | 684 | Shuttle Bobbin Case Position Finger for 5784..... |
| 5791 | 696 | Face Plate for 8174..... |
| 5793 | 727 | Thread Take-up Cam 8184 with 440c, for 43-5 and 43-6 Machines..... |
| 5795 | 686 | Tension Wheel with 5796, for 5797..... |
| *5796 | — | " " Flange for 5795..... |
| 5797 | — | Tension complete (wheel) for 8178 to 8180, 8182 and 13072, Nos. 2103, 5795, 8183 and two each 5983 and 5984..... |
| 5808 | 696 | Face Plate for 8177..... |
| 5810 | 684 | Shuttle Bobbin for 5783..... |
| 5811 | 695 | Arm Spool Pin and Thread Eyelet..... |
| 5814 | 728 | Vibrating Presser Foot for 43-5 Machine |
| 5816 | 728 | Lifting Presser Foot for 43-5 Machine... |
| 5820 | 727 | Face Plate for 8181..... |
| 5821 | 727 | Lifting Lever for 5825..... |
| 5823 | 676 | " " Adjusting Slide Roller for 5825..... |

| NO. | PLATE | NAME |
|-------|-------|---|
| 5824 | 676 | Lifting Lever Adjusting Slide Roller Pin for 5825..... |
| 5825 | — | Lifting Lever complete for 43-3 Machine, Nos. 1068D, 2653, 5821, 5823, 5824, 5878 and 5879..... |
| 5826 | 676 | Lifting Cam for 13043..... |
| 5827 | 727 | Presser Bar Lifting Bracket with two 453c, for 43-1 Machine..... |
| 5827 | 727 | Lifting Presser Bar Lifting Bracket with two 453c, for 43-3 Machine..... |
| 5830 | 676 | Vibrating Presser Hinge Bracket with 453c, for 43-3 Machine..... |
| 5831 | 676 | Vibrating Presser Spring for 43-3 Machine |
| 5835 | 676 | Lifting Lever Hinge Bracket for 5836.... |
| 5836 | — | " " " " 5835 with 4810, for 43-3 Machine..... |
| 5837 | 676 | Vibrating Presser Guide Bracket for 43-3 Machine..... |
| 5838 | 684 | Shuttle Bobbin Case Latch Spring for 5784 |
| 5878 | 3646 | Lifting Lever Adjusting Screw Head for 5825..... |
| 5879 | 3646 | Lifting Lever Adjusting Slide for 5825.. |
| 5885 | 3646 | Vibrating Presser Bar for 5886..... |
| 5886 | — | Vibrating Presser Bar complete for 43-3 Machine, Nos. 191F, 5885 and 5887.. |
| 5887 | 3646 | Vibrating Presser Foot for 5886..... |
| 5921 | 728 | Presser Foot (hinged) complete for 43-2 Machine, Nos. 5922 to 5924..... |
| 5922 | — | Presser Foot Bracket for 5921..... |
| 5923 | 686 | " " Plate Hinge Pin for 5921.... |
| 5924 | — | " " " for 5921..... |
| 5933 | 684 | Shuttle Bobbin Case Position Finger Rivet for 5784..... |
| 5934 | 684 | Shuttle Body for 5783..... |
| 5935 | 684 | " Tension Spring for 5784..... |
| 5952 | 678 | Thread Take-up Cam with 446c and 453c, for 43-1 Machine..... |
| *5954 | 678 | Thread Take-up Lever with 1819, for 8161 |
| 5960 | 678 | Bobbin Winder Friction Wheel (leather) for 13034 and 13035..... |
| 5961 | 678 | Bobbin Winder Friction Wheel Washer for 13034 and 13035..... |
| 5962 | 678 | Bobbin Winder Spindle for 13034..... |
| 5963 | 678 | " " " Flange for 13034 and 13035..... |

NUMERICAL LIST OF PARTS

| NO. | PLATE | NAME |
|----------------------------|-------|---|
| 5964 | — | Roller Presser complete, 1½ in. roller, for 43-1 and 43-4 Machines, Nos. 170D, 440F, 1549J, 1875, 2205, 2206, 8152, two 316F and three 1547J..... |
| 5966 | — | Oscillating Shaft Crank for 5967..... |
| 5967 | 681 | Oscillating Shaft Crank complete for 43-1 and 43-2 Machines, Nos. 453c, 1513J, 1885 and 5966..... |
| 5968 | 686 | Oscillating Shaft Crank Roller Cap Screw Washer for 1885..... |
| 5971 | 728 | Presser Foot (long shank) for 43-1 and 43-4 Machines..... |
| 5977 | 696 | Balance Wheel (two speed) for 5981..... |
| Nos. 5978 to 5980 FOR 5993 | | |
| 5978 | 696 | Driving Flange with two 435c..... |
| 5979 | 3632 | “ “ Latch..... |
| 5980 | 3632 | “ “ Spring..... |
| 5981 | — | Loose Wheel Attachment complete for 43-1 to 43-5 Machines, Nos. 5977 and 5993..... |
| 5982 | 696 | Face Plate for 8173..... |
| 5983 | 686 | Tension Washer (felt) for 5797..... |
| 5984 | 686 | “ “ (steel) for 5797..... |
| 5989 | — | Thread Retainer complete for 8178 to 8180, 8182 and 13072, Nos. 418E, 1502J, 10141 and two 2455..... |
| 5990 | 681 | Presser Bar Lifter for 43-1, 43-2 and 43-4 Machines..... |
| 5990 | 681 | Lifting Presser Bar Lifter for 43-3 Machine |
| 5991 | 686 | Thread Take-up Spring for 8178 to 8180, 8182 and 13072..... |
| 5993 | — | Driving Flange complete for 5981, Nos. 136F, 330D and 5978 to 5980..... |
| 5999 | — | Oscillating Shaft Crank for 6000..... |
| 6000 | 3632 | Oscillating Shaft Crank complete for 43-3 to 43-6 Machines, Nos. 453c, 1513J, 1885 and 5999..... |
| 6053 | 3543 | Drip Pan..... |
| 6055 | 730 | Machine Base Bolt Nut Washer for 13036 |
| 6055 | 730 | “ Bolt Nut Washer for 13036..... |
| 6107 | 696 | Arm Shaft for 5977, for 43-1 to 43-4 Machines..... |
| 6109 | 696 | Arm Shaft for 3011, for 43-1 to 43-4 Machines..... |
| 6178 | 3543 | Arm Shaft for 3011, for 43-5 and 43-6 Machines..... |

NUMERICAL LIST OF PARTS

| NO. | PLATE | NAME |
|-------|-------|---|
| 6179 | 3543 | Arm Shaft for 5977, for 43-5 Machine... |
| *6305 | — | Feed Lever Bracket with two 620c, for 13068..... |
| 6306 | 723 | Feed Bar Connecting Link for 43-6 Machine..... |
| 6307 | 723 | Feed Lever Hinge Pin for 43-6 Machine... |
| 6334 | 3543 | Rock Shaft Hanger with two wood screws 1 in. No. 10, for 6339..... |
| 6337 | 3543 | Rock Shaft Lifting Bracket with two 356c, for 6339..... |
| 6338 | 3543 | Rock Shaft Lifting Bracket Hook for 6339 |
| 6339 | 3543 | Rock Shaft complete for 13037, 13098 and 16645, Nos. 2763, 2770, 6337, 6338, 16647 and two 6334..... |
| 6343 | 3543 | Pitman for 16645..... |
| 6436 | 727 | Oil Cup with 1111E and three 6437..... |
| 6437 | 723 | “ “ Thread Eyelet for 6436..... |
| 6466 | 678 | Presser Bar Spring for 43-1 Machine..... |
| 6703 | 3543 | Pitman, length 14½ in., for 13037 and 13098..... |
| 7071 | 695 | Binder Screw Washer for 120178..... |
| 7071 | 695 | Guide Screw Washer for 43-6 Machine... |
| 7071 | 695 | “ Thumb Screw Washer for 120177... |
| 7170 | 3543 | Lifting Lever for 13037..... |
| 7299 | 727 | “ Presser Bar for 43-3 Machine..... |
| 7958 | 695 | Pitman Pin for 25246..... |
| 8152 | 723 | Roller Arm for 5964..... |
| 8159 | — | Thread Take-up Lever 5758 with 1088c, for 43-4 and 43-6 Machines..... |
| 8161 | — | Thread Take-up Lever 5954 with 1088c, for 43-1 and 43-2 Machines..... |
| *8162 | — | Shuttle Frame 5752 with 590D, 11854, 12001 and 12002, for 5751 and 8189... |
| 8173 | — | Face Plate 5982 with 2105, for 8179..... |
| 8174 | — | “ “ 5791 with 2105, for 8178..... |
| 8177 | — | “ “ 5808 with 2105, for 8180..... |
| 8178 | — | Face Plate complete for 43-5 Machine, Nos. 233D, 448c, 2108, 2127, 5797, 5989, 5991 and 8174..... |
| 8179 | — | Face Plate complete for 43-2 and 43-4 Machines, Nos. 448c, 2107, 2127, 5797, 5989, 5991, 8173 and two 233D..... |
| 8180 | — | Face Plate complete for 43-1 Machine, Nos. 448c, 2107, 2127, 5797, 5989, 5991, 8177 and two 233D..... |
| *8181 | — | Face Plate 5820 with 2105, for 8182..... |

| NO. | PLATE | NAME |
|--------|-------|---|
| 8182 | — | Face Plate complete for 43-3 Machine, Nos. 233b, 448c, 2127, 5797, 5989, 5991 and 8181. |
| 8183 | — | Tension Screw Stud 817c with 1560c, for 5797. |
| *8184 | — | Thread Take-up Cam for 5793. |
| *8185 | — | “ “ “ “ 5757. |
| 8187 | 730 | Shuttle Cylinder for 8194. |
| 8188 | 730 | “ Tension Spring for 8194. |
| 8189 | 730 | Shuttle (cylinder) 2½ in. diam., complete, for 43-3 to 43-6 Machines, Nos. 8162, 8194, 12000 and 14535. |
| *8194 | — | Shuttle Cylinder 8187 with 773f and 8188, for 8189. |
| 8879 | 7801 | Arm Spool Pin Washer (cloth). |
| 8908 | 5901 | Wrench for 1520 (Accessories). |
| 10141 | 685 | Bobbin Winder Tension Spring for 27325. |
| 10141 | 685 | Thread Retaining Spring for 5989. |
| 11165 | 695 | Oscillating Rock Shaft Oil Pad for 13009. |
| 11241 | 7800 | Bobbin Winder Spool Washer (cloth) for 27325. |
| 11742 | 695 | Pitman Washer for 25246. |
| 11854 | 730 | Shuttle Cylinder Latch Spring for 8162. |
| 12000 | 685 | “ “ Hinge Pin for 5751 and 8189. |
| 12001 | 685 | Shuttle Cylinder Latch for 8162. |
| 12002 | 685 | “ “ “ Pin for 8162. |
| 12093 | 685 | “ “ for 56514, obsolete. |
| 12095 | 685 | “ Tension Spring for 56514, obsolete. |
| 12169 | 715 | Bobbin Winder Frame for 13034 and 13035. |
| 12170 | 715 | “ “ Spring for 13032 and 13033. |
| 12296 | 686 | Thread Eyelet (side of arm). |
| *13001 | — | Cylinder, 3¼ in. diam., for 43-1 and 43-2 Machines. |
| 13002 | 717 | Crank Connecting Rod with 4349 and two 158E. |
| 13003 | 719 | Face Plate for 600 and 2111 for 43-1 and 43-2 Machines, obsolete. |
| 13004 | 716 | Feed Dog, 12 teeth, for 43-1 Machine. |
| 13005 | 715 | “ “ Carrier for 43-1 to 43-5 Machines. |
| 13006 | 717 | Feed Forked Connection for 43-1 to 43-5 Machines. |
| 13007 | 717 | Feed Rock Shaft for 43-1 to 43-5 Machines. |
| 13008 | 715 | “ “ “ Crank for 43-1 to 43-5 Machines. |

| NO. | PLATE | NAME |
|--------|-------|--|
| *13009 | 715 | Oscillating Rock Shaft with 11165, for 13062. |
| 13010 | 717 | Oscillating Shaft for 43-1 and 43-2 Machines, obsolete. |
| 13011 | 721 | Shuttle Driver and Feed Cam for 43-1 and 43-2 Machines, obsolete. |
| 13012 | 715 | Shuttle Race Ring for 43-1 and 43-2 Machines. |
| 13013 | 715 | Shuttle Race Ring Cap for 13014. |
| 13014 | — | Shuttle Race Ring Cap complete for 43-1 and 43-2 Machines, Nos. 13013, 13015 and two 240b. |
| 13015 | 721 | Shuttle Race Cap Latch for 13026, 13088 and 13095. |
| 13015 | 721 | Shuttle Race Ring Cap Latch for 13014. |
| 13016 | 716 | Throat Plate for 13004. |
| 13017 | 678 | Thread Take-up Cam with 446c, for 43-2 Machine. |
| 13018 | 715 | Feed Cam with 446c, for 43-1 Machine. |
| *13019 | — | Arm with 4448 and 4449, for 43-2 and 43-4 Machines. |
| *13020 | — | Cylinder, 3¼ in. diam., for 43-3 to 43-5 Machines. |
| 13021 | 725 | Feed Dog, for leather, 12 teeth, for 43-4 Machine, obsolete. |
| 13022 | 717 | Oscillating Shaft for 43-1 and 43-2 Machines. |
| 13023 | 715 | Shuttle Driver and Feed Lifting Eccentric for 43-3 to 43-6 Machines. |
| 13024 | 715 | Shuttle Race for 43-3 to 43-5 Machines. |
| 13025 | 717 | “ “ Cap for 13026. |
| 13026 | — | Shuttle Race Cap complete for 43-3 to 43-5 Machines, Nos. 13015, 13025 and two 240b. |
| 13027 | 725 | Throat Plate for 13021, obsolete. |
| 13028 | 716 | Feed Dog, two rows of teeth, for 43-2 Machine. |
| 13029 | 716 | Presser Foot (solid) short shank, for 43-2 Machine. |
| 13030 | 716 | Throat Plate for 13028. |
| 13031 | 715 | Bobbin Winder Bracket for 13032 and 13033. |
| 13032 | 715 | Bobbin Winder complete for 14535, Nos. 32b, 180b, 12170, 13031 and 13035. |
| 13033 | — | Bobbin Winder complete for 5810, Nos. 32b, 180b, 12170, 13031 and 13034. |

| NO. | PLATE | NAME |
|-------|-------|---|
| 13097 | 729 | Throat Plate Extension, for attaching visors to uniform caps..... |
| 13098 | — | Knee Lifter complete for 43-5 Machine, Nos. 802D, 4725 to 4727, 6339, 6703, 16648 and 16659..... |
| 14535 | 685 | Shuttle Bobbin for 5751 and 8189..... |
| 15072 | 7801 | Bobbin Winder Bobbin Position Pin for 27330..... |
| 15472 | 3633 | Needle Bar Connecting Stud with 155c, for 56764..... |
| 16641 | 3543 | Lifting Lever with 448c, for 16645..... |
| 16645 | — | Knee Lifter complete for 43-6 Machine, Nos. 1064D, 4725, 4726, 4896, 6339, 6343, 16641 and 16659..... |
| 16646 | 3543 | Rock Shaft Knee Arm for 16647..... |
| 16647 | — | Rock Shaft Knee Arm complete for 6339, Nos. 2766, 2767 and 16646..... |
| 16648 | 3543 | Lifting Lever with 448c, for 13098..... |
| 16659 | 3543 | " " Spring for 13037, 13098 and 16645..... |
| 16780 | 727 | Vibrating Presser Bar for 16781..... |
| 16781 | — | Guide Bar complete for 43-5 Machine, Nos. 810D, 810E, 4723, 4897, 16780, 56844 and three 404D..... |
| 17547 | 7801 | Thread Unwinder Tension Thread Guard for 60609..... |
| 17830 | 5695 | Guide Tension Spring Steady Pin for 120176..... |
| 19088 | 5695 | Guide Tension Block Rivet for 120175... |
| 24630 | 730 | Feed Cam with two 435c, for 43-6 Machine..... |
| 25010 | 381 | Band Wheel Crank for 25133..... |
| 25029 | 695 | Belt Hook for 25176..... |
| 25065 | 381 | Leg for 25246..... |
| 25074 | 381 | Pitman (adjustable) complete with two each 558E, 1570E, 25075 and 25123, for 25246..... |
| 25075 | 695 | Pitman Adjusting Screw Washer for 25074 |
| 25077 | 381 | Table Support for 25246..... |
| 25082 | 381 | Treadle for 25246..... |
| 25086 | 381 | Wrench for 1507 and 1510, for 25246.... |
| 25123 | — | Pitman Adjusting Block for 25074..... |
| 25133 | 381 | Band Wheel (two speed) 10 in. and 12 in. diam., with 2117 and 25010, for 25240 |
| 25176 | — | Belt, size $\frac{1}{8}$ in., length 68 in., with 25029, for 25246..... |

| NO. | PLATE | NAME |
|-------|-------|--|
| 25246 | — | Stand (iron work) complete, Nos. 1059E, 7958, 11742, 25074, 25077, 25082, 25086, 25133, 25368, two 25065 and four 506E |
| 25368 | 381 | Brace with three 46629, for 25246..... |
| 26026 | 5901 | Screw Driver, large (Accessories)..... |
| 26485 | 5901 | " " small (Accessories)..... |
| 27302 | 7805 | Bobbin Winder Frame for 27648..... |
| 27303 | 7801 | " " " Spring for 27648 and 27649..... |
| 27323 | 7805 | Bobbin Winder Spool Pin for 27325..... |
| 27324 | 7805 | " " " Stand for 27325.... |
| 27325 | 7805 | Bobbin Winder Spool Stand complete for 27550 and 27551, Nos. 418E, 1562J, 10141, 11241, 27323, 27324, 34358M and two each 2455 and wood screws 1 in. No. 10..... |
| 27330 | 7800 | Bobbin Winder Spindle with 15072, for 27649..... |
| 27331 | 7800 | Bobbin Winder Stop Latch for 27649.... |
| 27333 | 7805 | " " Spindle for 27648..... |
| 27334 | 7805 | " " Stop Latch for 27648.... |
| 27527 | 7800 | " " Frame for 27649..... |
| 27540 | 7800 | " " Base for 27648 and 27649 |
| 27541 | 7800 | " " Pulley for 27648 and 27649..... |
| 27550 | — | Bobbin Winder (swinging automatic, right hand) complete for 5810, Nos. 27325 and 27648..... |
| 27551 | — | Bobbin Winder (swinging automatic, right hand) complete for 14535, Nos. 27325 and 27649..... |
| 27555 | 3582 | Thread Unwinder Spool Pin for 41451.... |
| 27557 | 3582 | " " " Stand with 138B, for 41451..... |
| 27560 | 3582 | Thread Unwinder Thread Guard Rod, 26 in. long, for 41451..... |
| 27648 | 7805 | Bobbin Winder for 27550, Nos. 35D, 1620r, 27302, 27303, 27333, 27334, 27540, 27541, 50356D and two wood screws 1 in. No. 7..... |
| 27649 | 7800 | Bobbin Winder for 27551, Nos. 35D, 1620r, 27303, 27330, 27331, 27527, 27540, 27541, 50356D and two wood screws 1 in. No. 7..... |
| 27916 | 3583 | Bobbin Winder Brake (leather) for 41439. |
| 28084 | 3583 | " " " Rivet for 41439.... |

NUMERICAL LIST OF PARTS

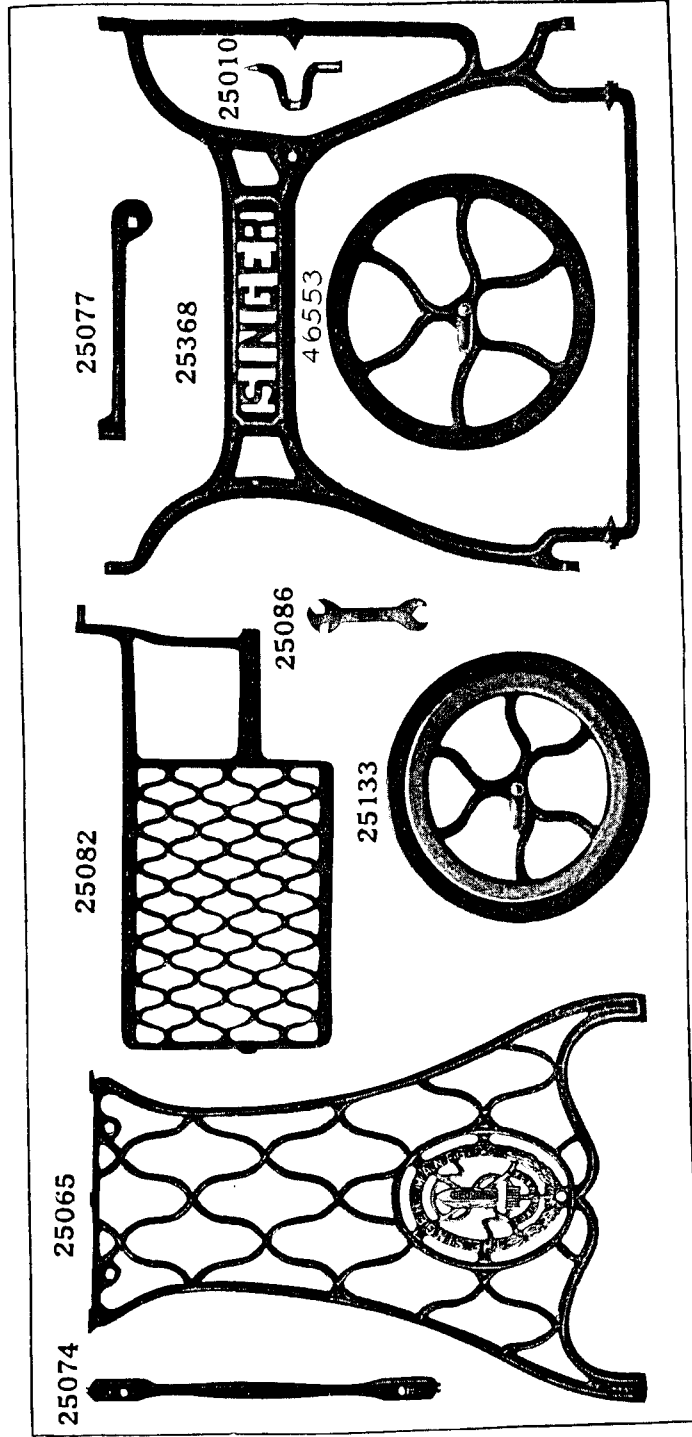
| NO. | PLATE | NAME |
|-------------------------------|-------|---|
| 34358 | 730 | Bobbin Winder Tension Thread Guide for 27325..... |
| 41398 | 3583 | Bobbin Winder Bobbin Carrier Key for 41444..... |
| Nos. 41439 TO 41447 FOR 41448 | | |
| 41439 | 7804 | Bobbin Winder Base with 458c, 27916 and two 28084..... |
| 41440 | 3581 | Bobbin Winder Frame..... |
| 41441 | 3581 | " " " Hinge Pin..... |
| 41442 | 3581 | " " " Spring..... |
| 41443 | 3581 | " " Pulley with 155c..... |
| 41444 | 7804 | " " Spindle with 41398..... |
| 41445 | 7804 | " " Stop Latch..... |
| 41446 | 7804 | " " " " Hinge Pin.... |
| 41447 | 3581 | " " Tripping Arm with 176b.. |
| 41448 | 7804 | Bobbin Winder for 41449, Nos. 2269, 41439 to 41447, two 4784 and three wood screws 1 in. No. 7..... |
| 41449 | — | Bobbin Winder (swinging automatic, right hand) complete for 14535, Nos. 41448 and 41454..... |
| 41450 | 3582 | Thread Unwinder Spool Rest for 41451... |
| 41451 | — | " " " " 41450 with 138b and 27555, for 41454..... |
| 41454 | 3582 | Thread Unwinder complete, for one large spool, for 41449, Nos. 27557, 27560, 41451, 41514, 60609 and three wood screws 1¼ in. No. 12..... |
| 41514 | 3582 | Thread Unwinder Spool Weight, 4 in. diam., with 41515, for 41454..... |
| 41515 | 3583 | Thread Unwinder Spool Weight Centre Pin for 41514..... |
| 46629 | — | Band Wheel Crank Screw Centre 297c with 1507j, for 25368..... |
| 46629 | — | Treadle Screw Centre 297c with 1507j, for 25368..... |
| 50356b | 7801 | Bobbin Winder Frame Hinge Screw for 27648 and 27649..... |
| 56514 | — | Shuttle Cylinder 12093 with 773f and 12095, for 5751, obsolete..... |
| 56752 | — | Guide Bar 3126 with 2361 and two 2362, for 56844..... |
| 56764 | — | Needle Bar Connecting Link 4898 with 15472, for 43-5 and 43-6 Machines.... |
| 56773 | — | Needle Bar Connecting Link 3045 with 2052, for 43-2 and 43-4 Machines..... |

NUMERICAL LIST OF PARTS

| NO. | PLATE | NAME |
|----------------------------------|-------|---|
| 56812 | — | Oscillating Rock Shaft Hinge Pin 3052 with 1513j, for 13062..... |
| 56815 | — | Needle Bar Connecting Link 3045 with 3147, for 43-3 Machine..... |
| 56844 | — | Guide Bar 56752 with 337b and 3137, for 16781..... |
| 60608 | 3582 | Thread Unwinder Thread Guard for 60609 |
| 60609 | — | Thread Unwinder Thread Guard complete for 41454, Nos. 330b, 828c, 1560c, 2103, 5769, 17547, 60608 and two 2102..... |
| 120167 | 5664 | Guide, for band of caps, for stitching visors and sweat bands in one operation, for 43-6 Machine..... |
| 120168 | 5664 | Guide, for visors, for stitching visors and sweat bands in caps in one operation, for 43-6 Machine..... |
| 120169 | 5664 | Guide, for visors, when cushion is fitted on visor and sweat band stitched in by hand, for 43-6 Machine..... |
| Nos. 120170 TO 120173 FOR 120177 | | |
| 120170 | 5695 | Guide..... |
| 120171 | 5695 | " Block..... |
| 120172 | 5695 | " Body..... |
| 120173 | 5695 | " Shank..... |
| 120174 | 5695 | " Tension Block for 120175..... |
| 120175 | 5695 | " " " Holder with 120174 and two 19088, for 120177..... |
| 120176 | 5695 | Guide Tension Spring with 17830, for 120177..... |
| 120177 | — | Guide (adjustable) complete, for sweat bands, for stitching visors and sweat bands in caps in one operation, for 43-6 Machine, Nos. 658b, 732b, 7071, 120170 to 120173, 120175, 120176 and four 234b..... |
| 120178 | 5664 | Binder on Shank, for visor cushion, for 43-6 Machine..... |
| 120179 | 5664 | Binder Stop Stud for 13083 and 120178.. |
| 120342 | 5901 | Oiler (copper plated) with 120343 (Accessories)..... |
| 120343 | 5901 | Oiler Spout, 3½ in. long, for 120342..... |

ILLUSTRATIONS
OF
PARTS

From the library of: Diamond Needle Corp



From the library of: Diamond Needle Corp

PLATE 676—FULL SIZE

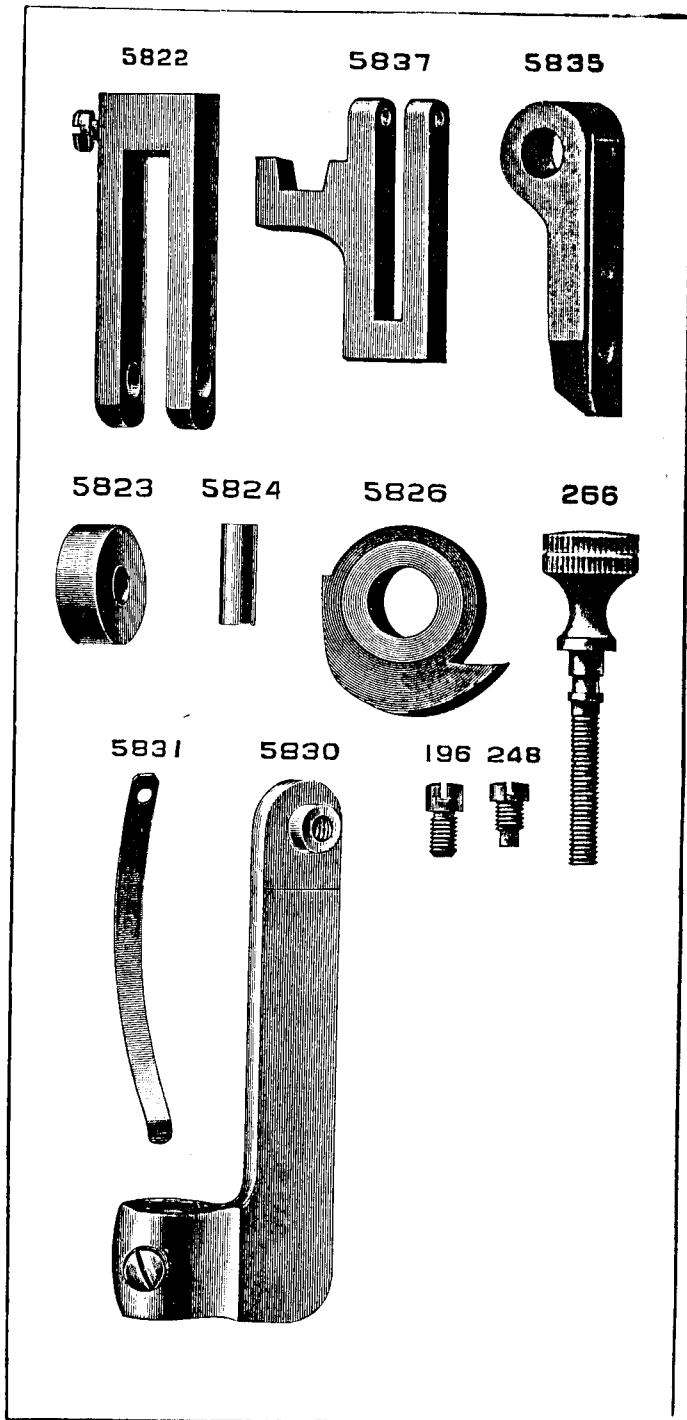


PLATE 678—ONE-HALF SIZE

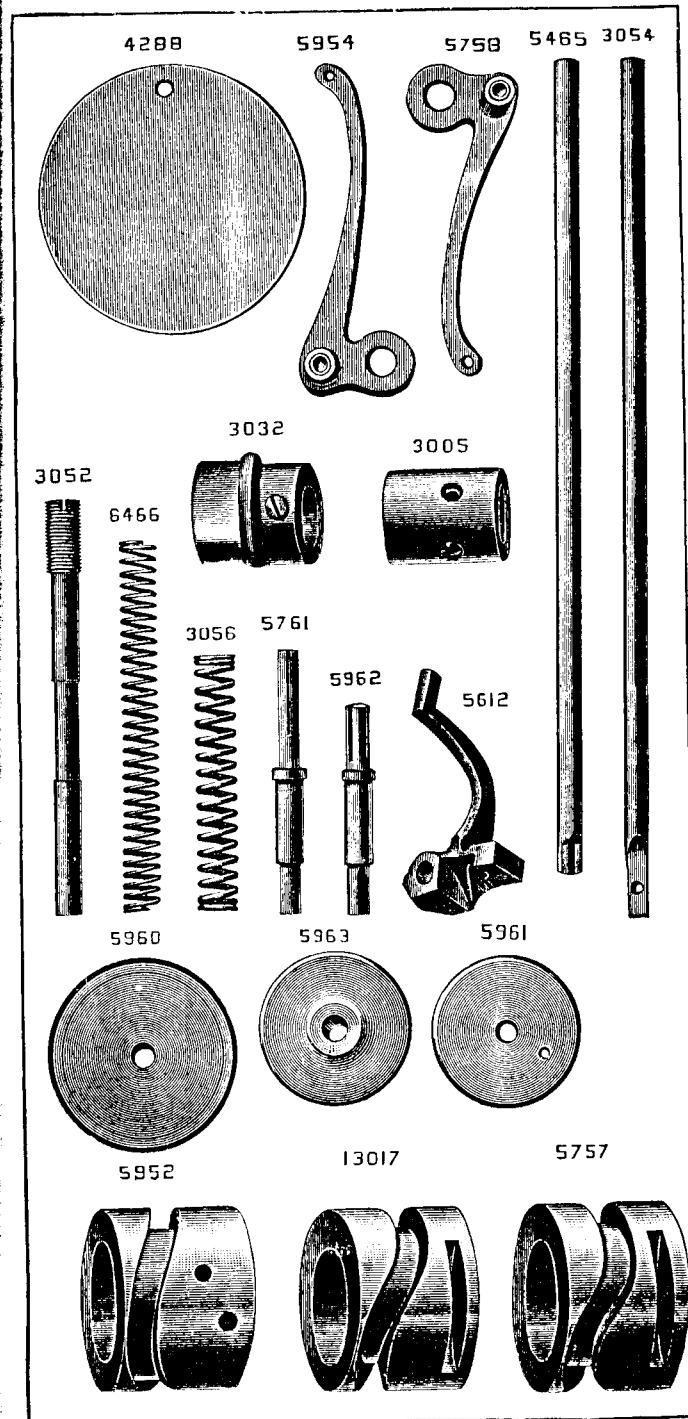


PLATE 681—FULL SIZE

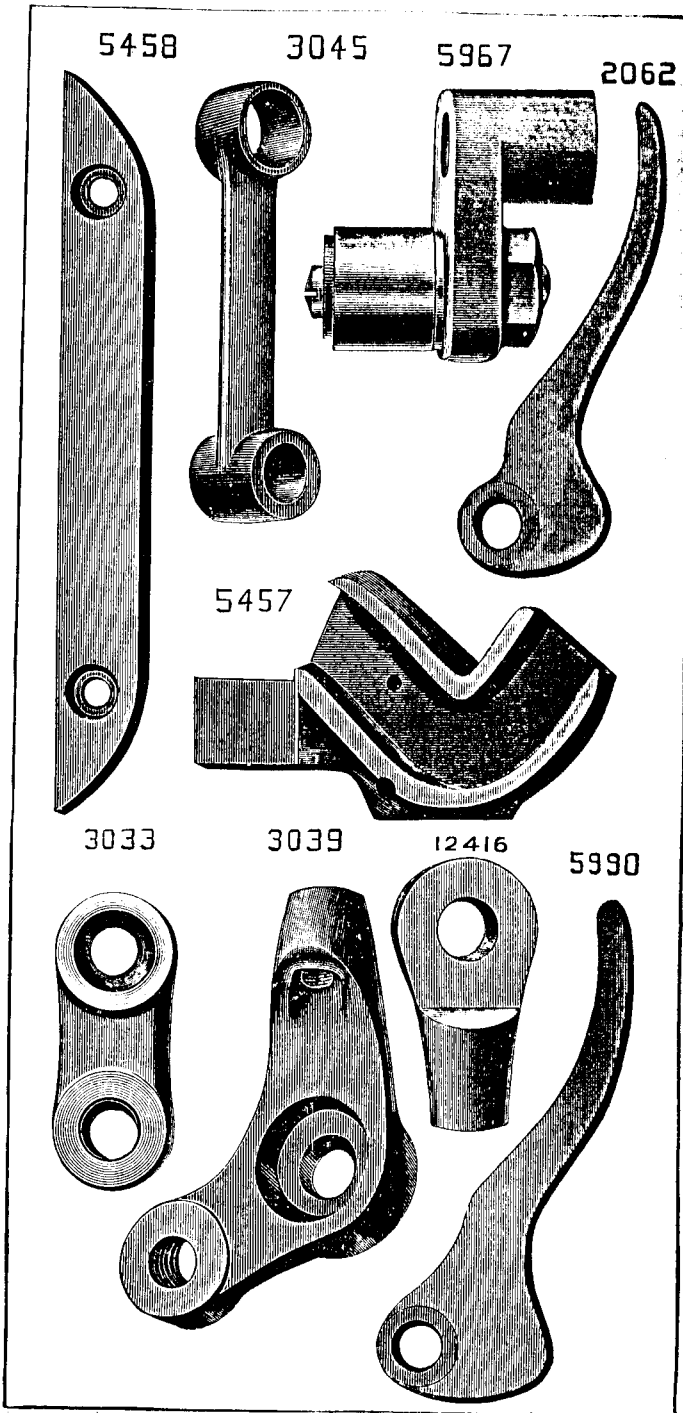


PLATE 684—FULL SIZE

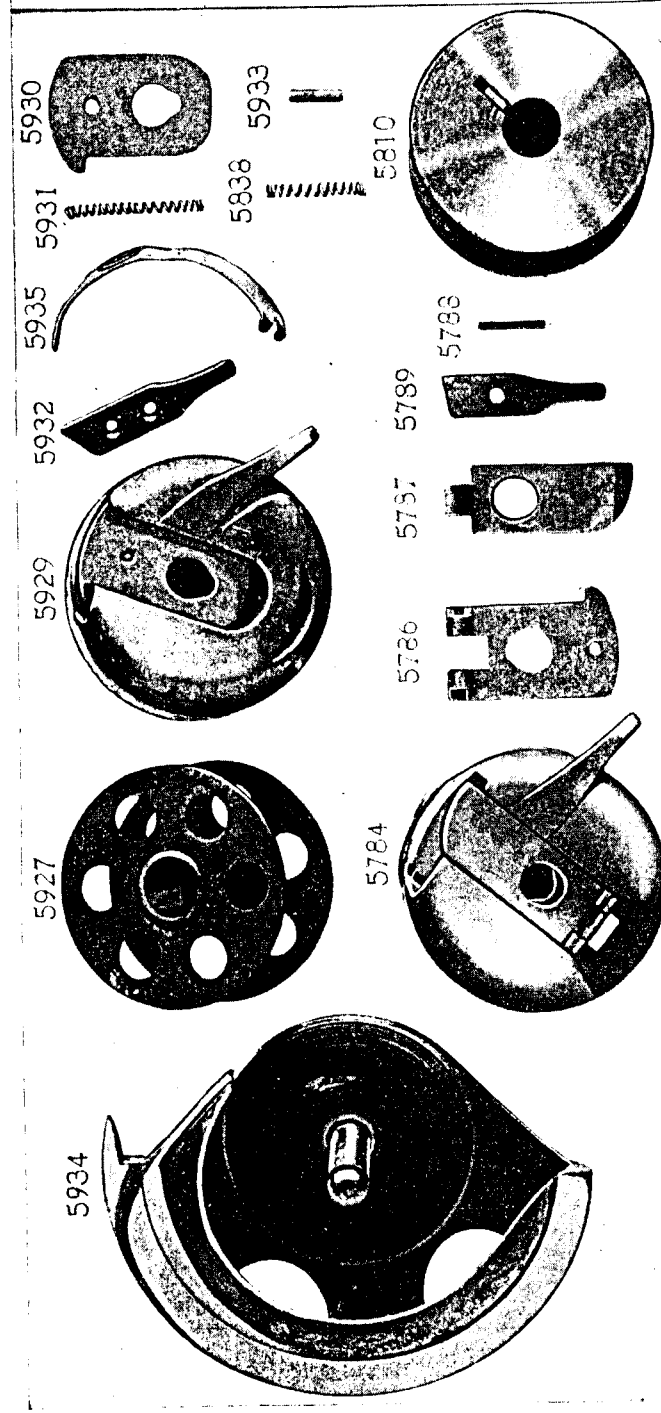


PLATE 685—FULL SIZE

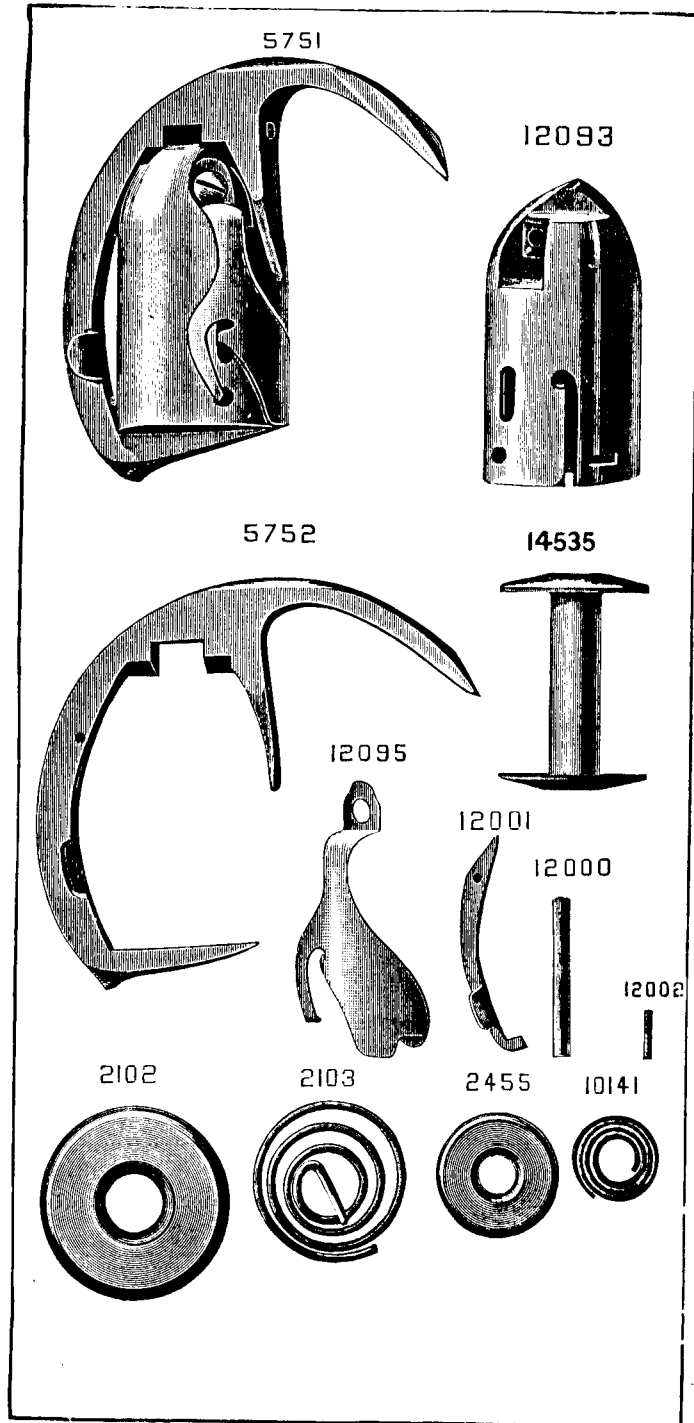


PLATE 686—FULL SIZE

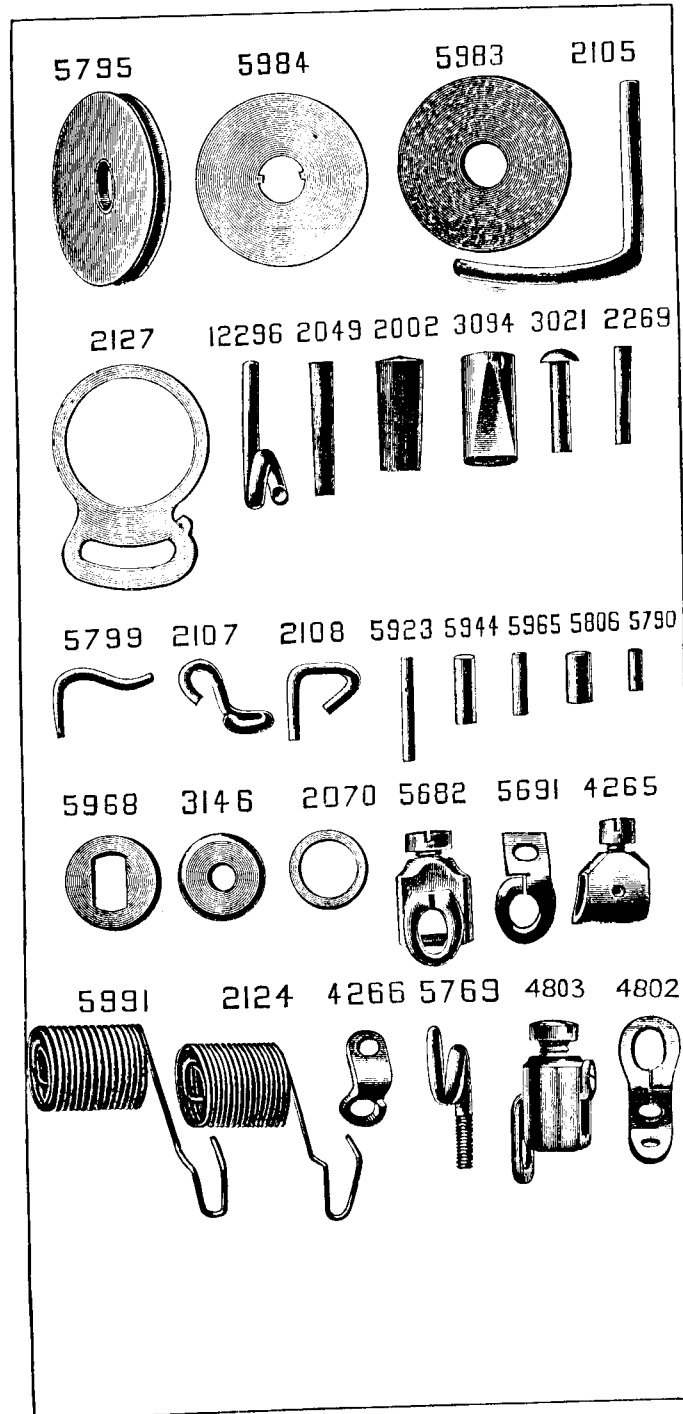


PLATE 691—FULL SIZE

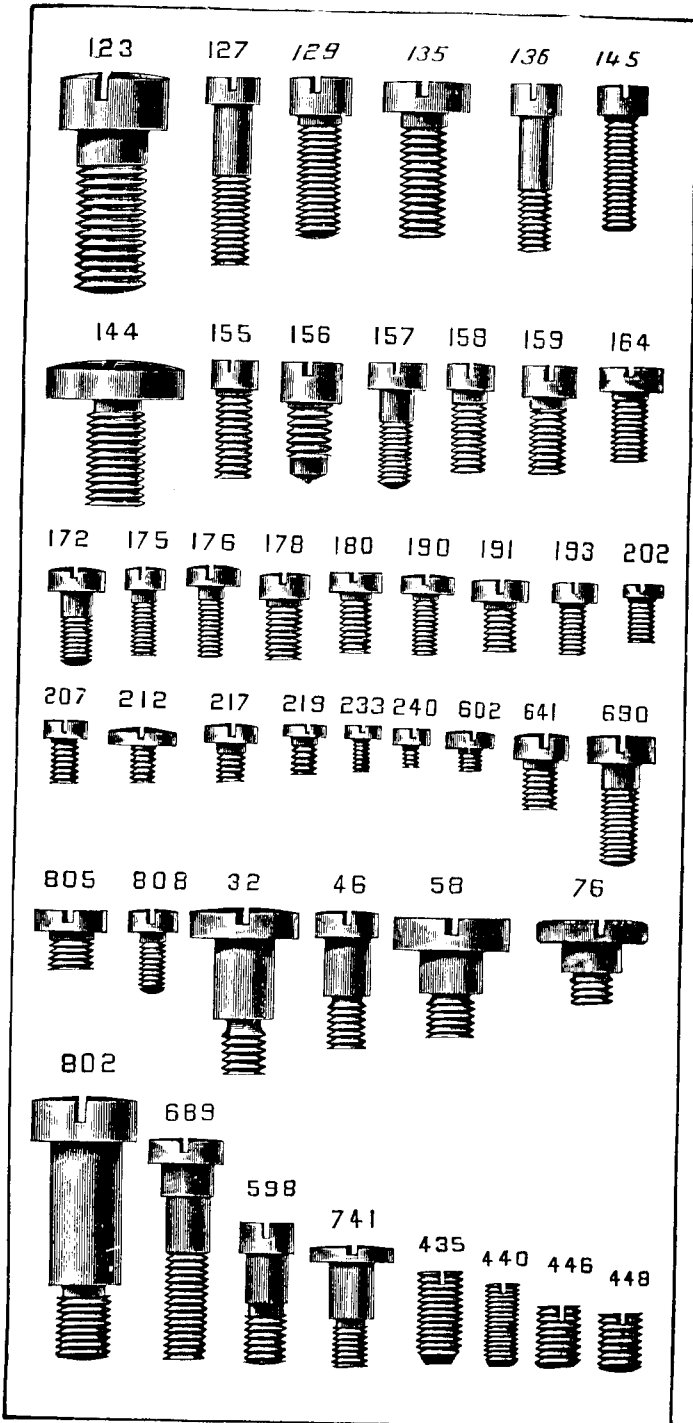


PLATE 692—FULL SIZE

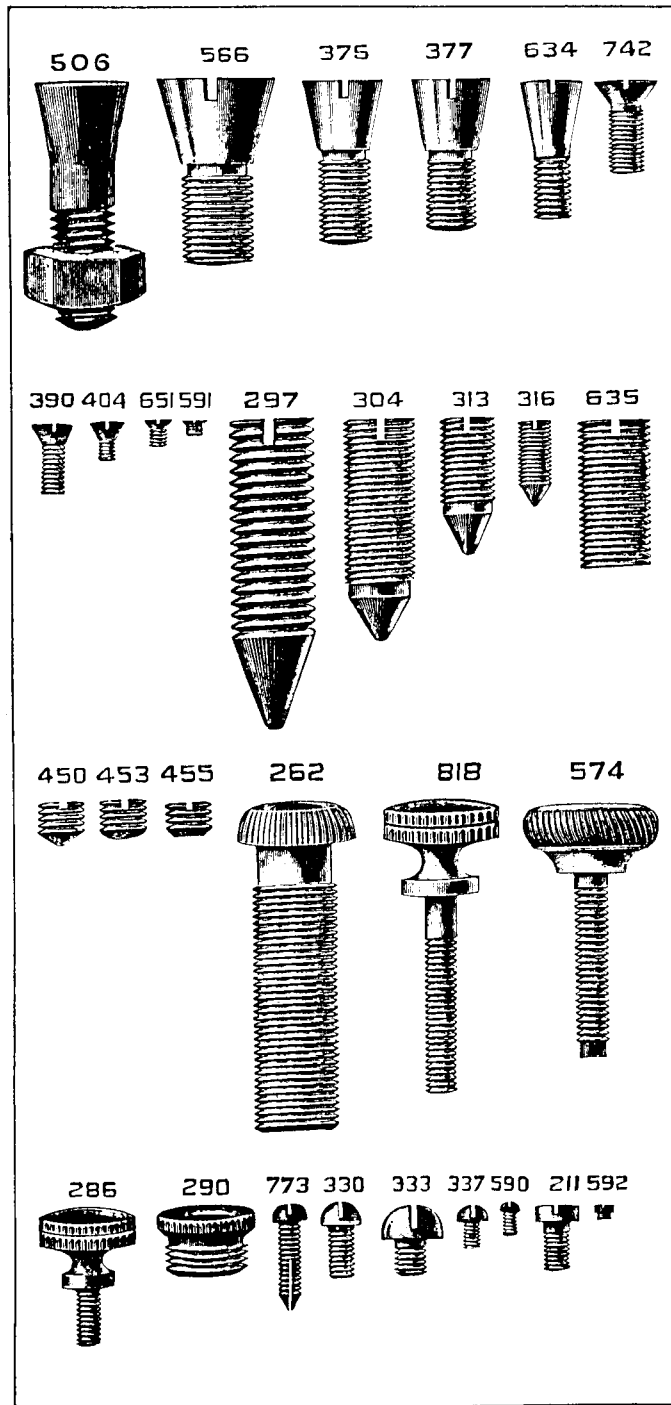


PLATE 693—FULL SIZE

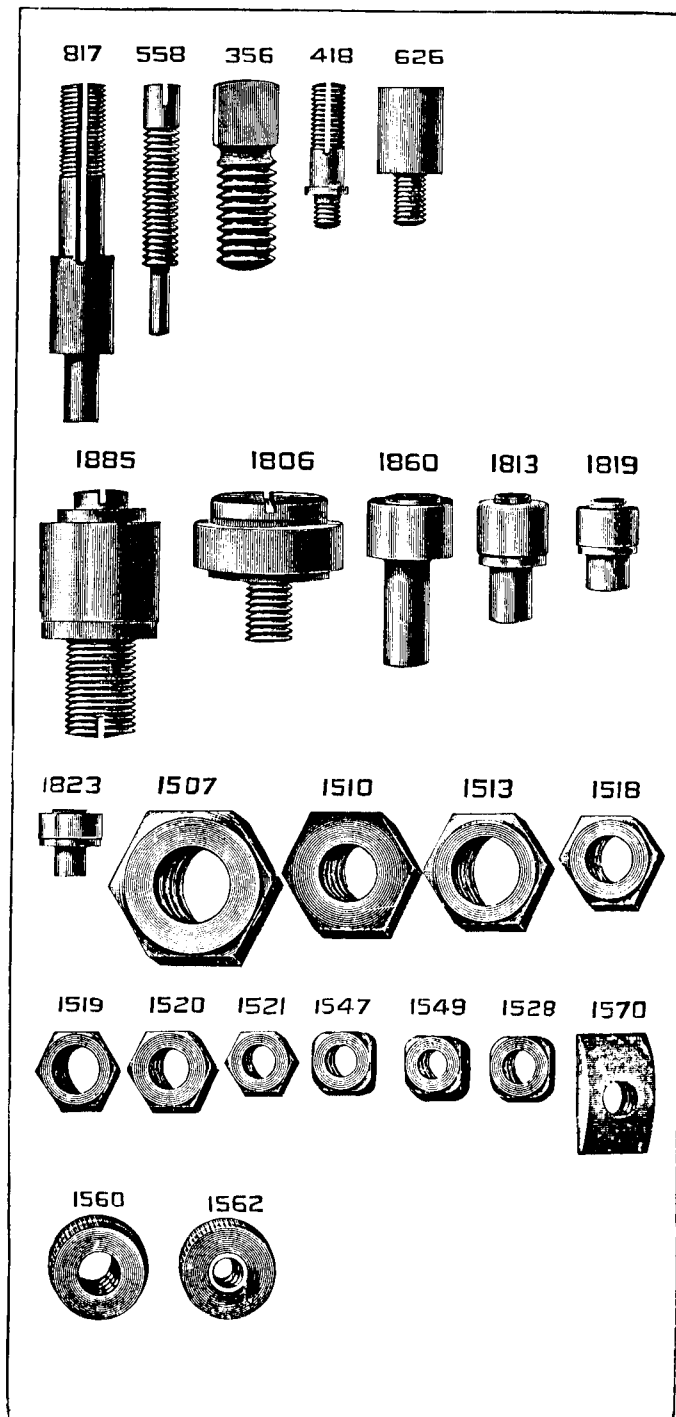


PLATE 695—FULL SIZE

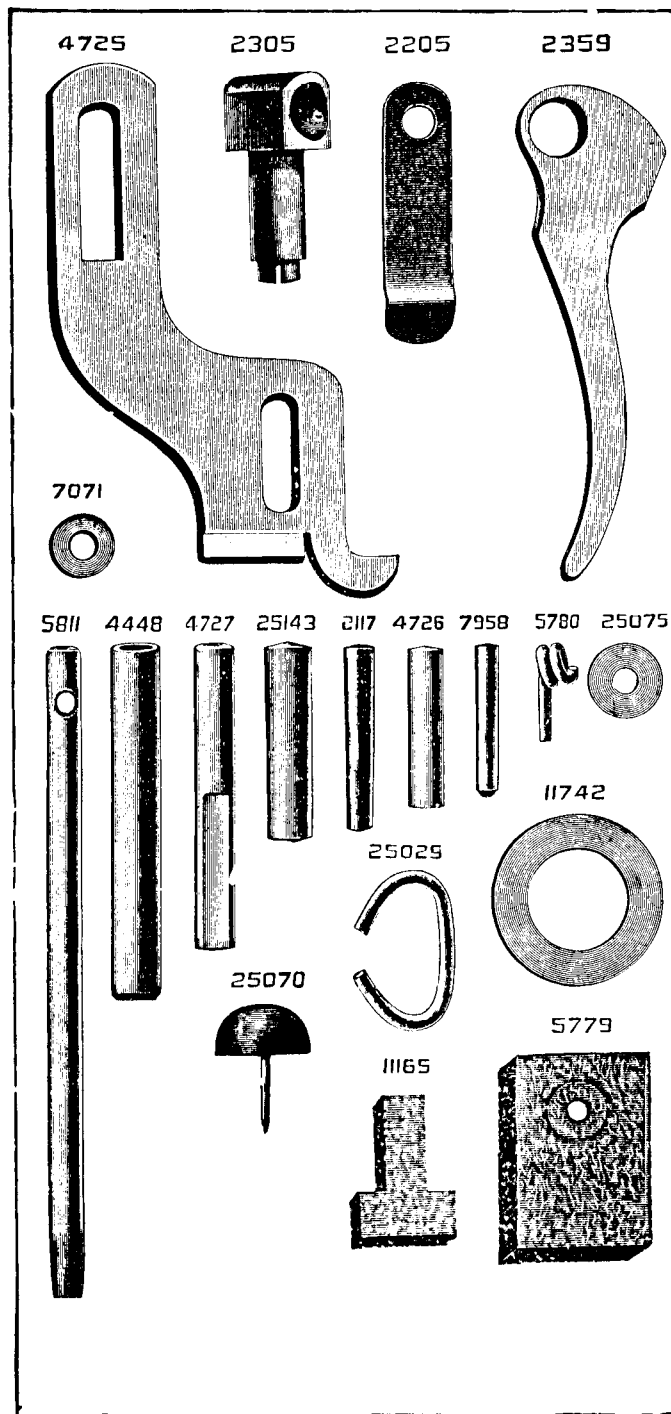


PLATE 696—ONE-FOURTH SIZE

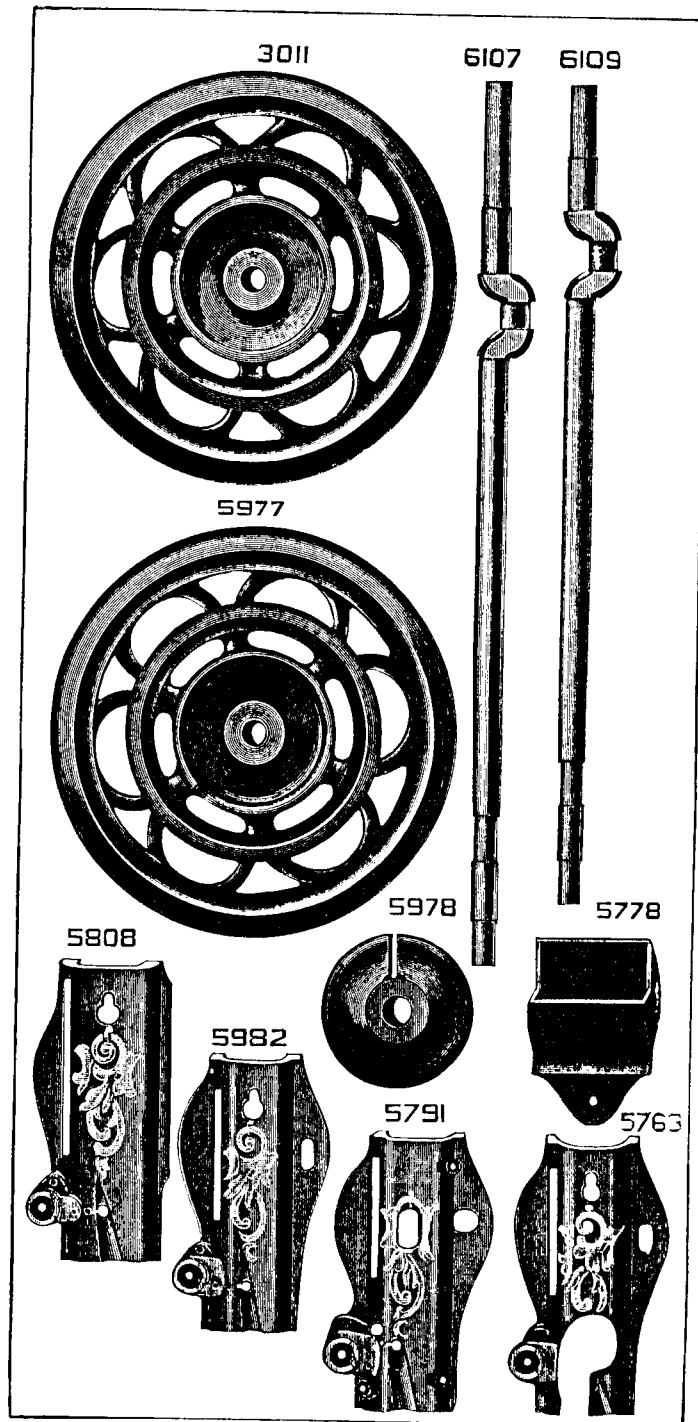


PLATE 715—ONE-HALF SIZE

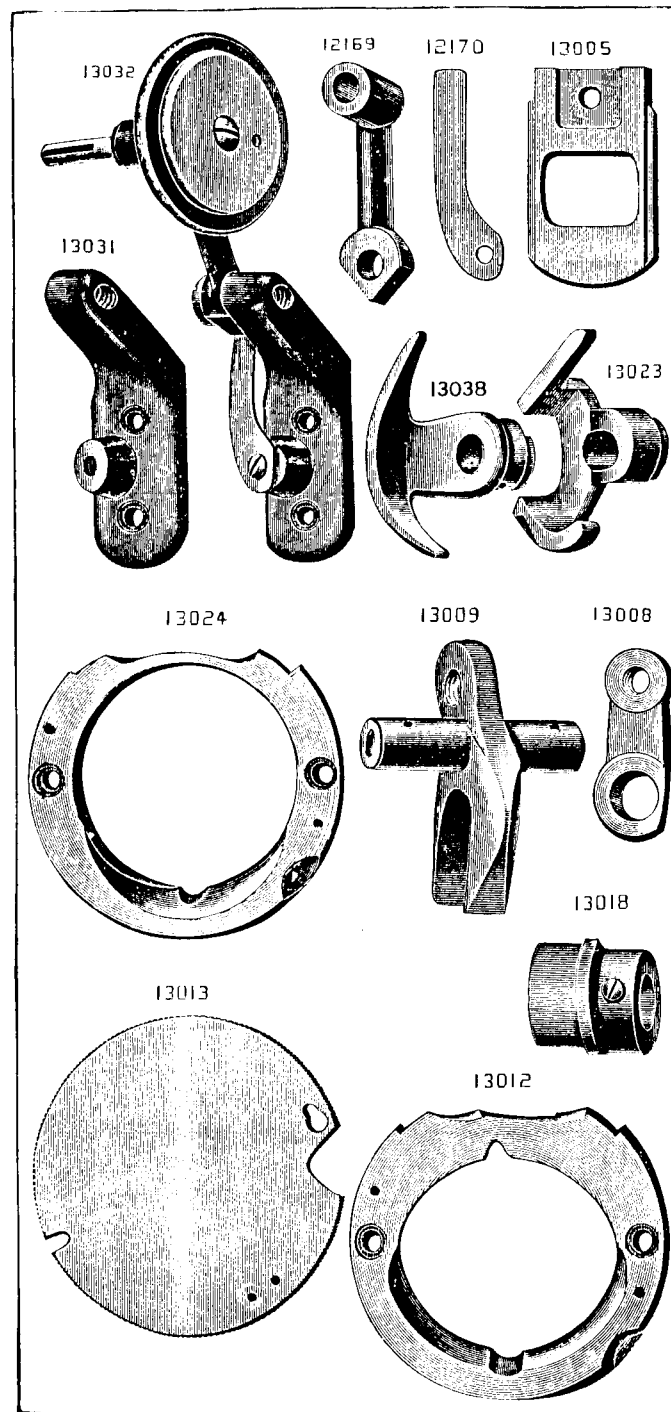


PLATE 716--FULL SIZE

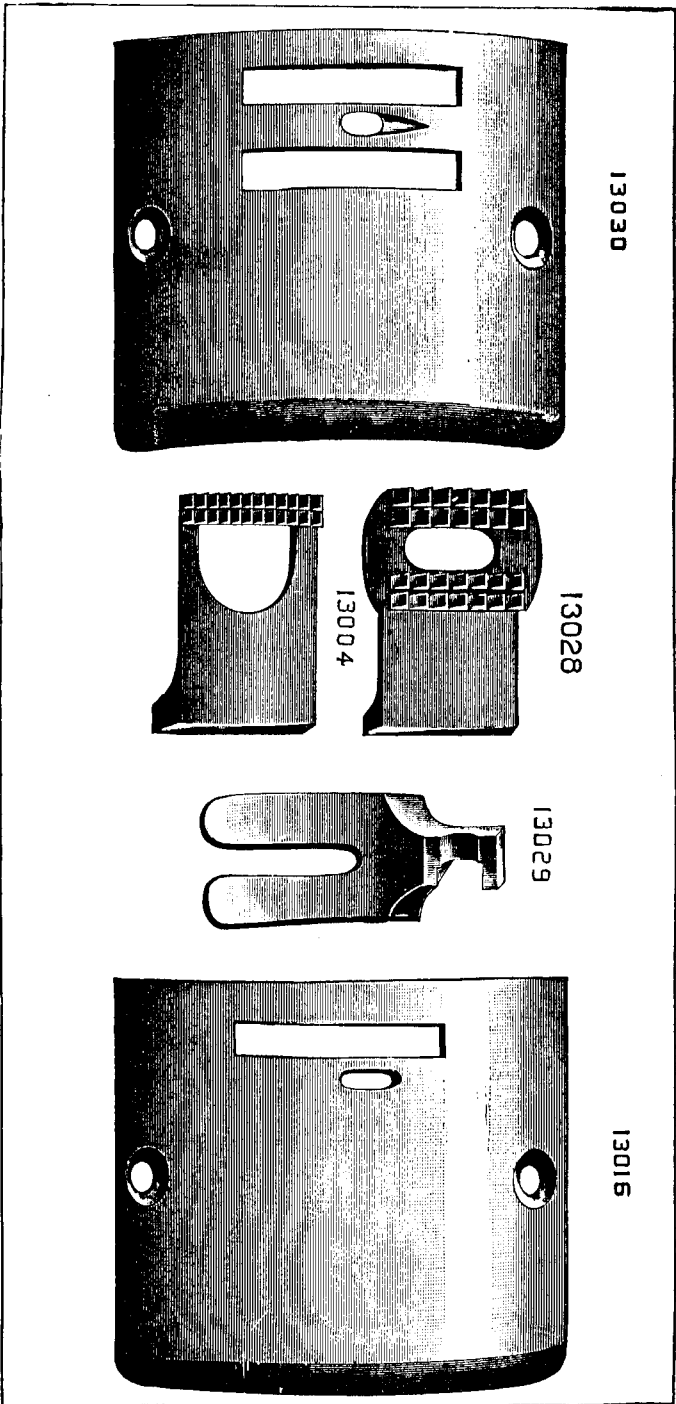


PLATE 717--ONE-HALF SIZE

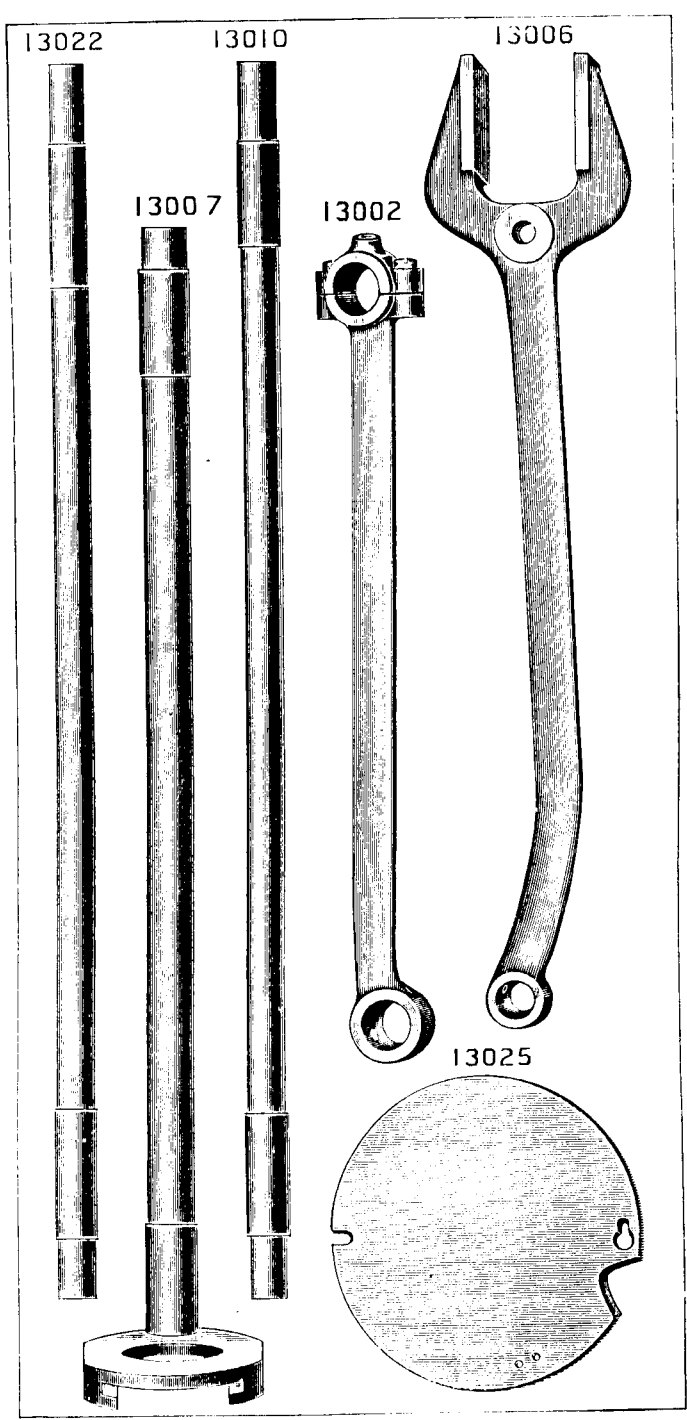


PLATE 718—ONE-FOURTH SIZE

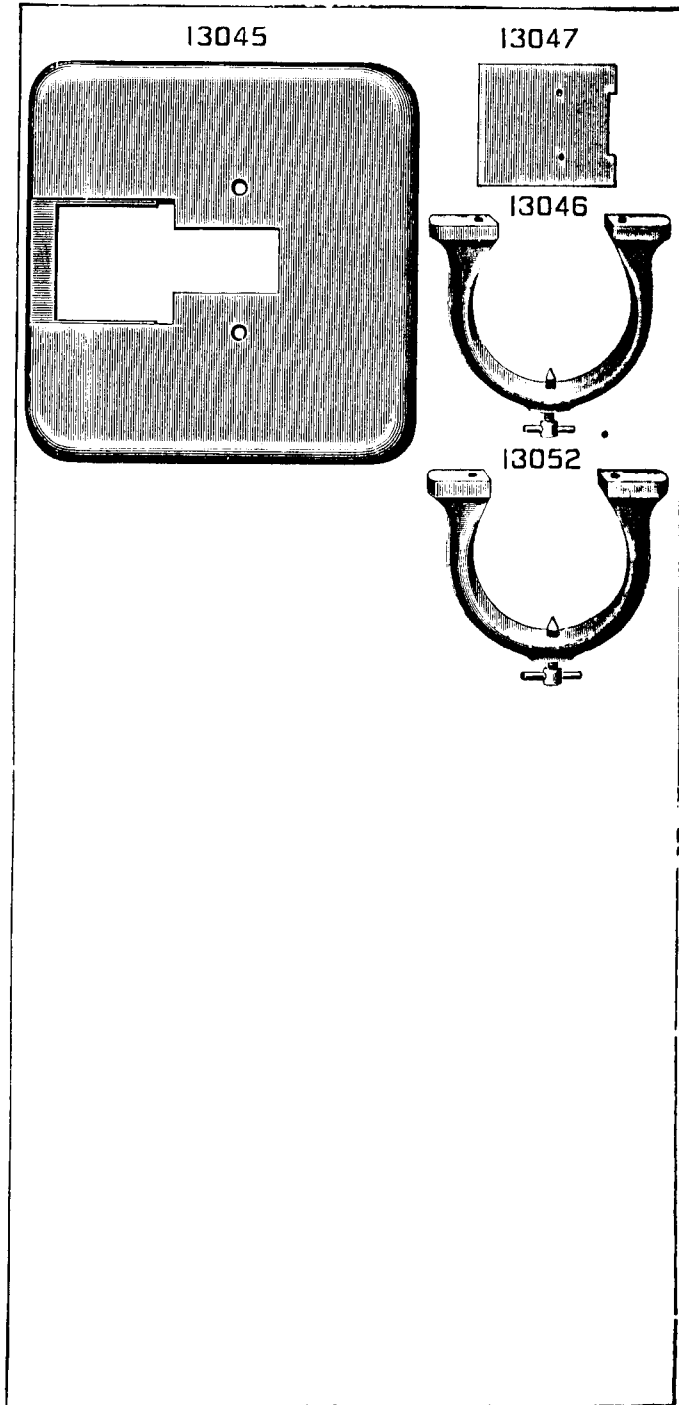
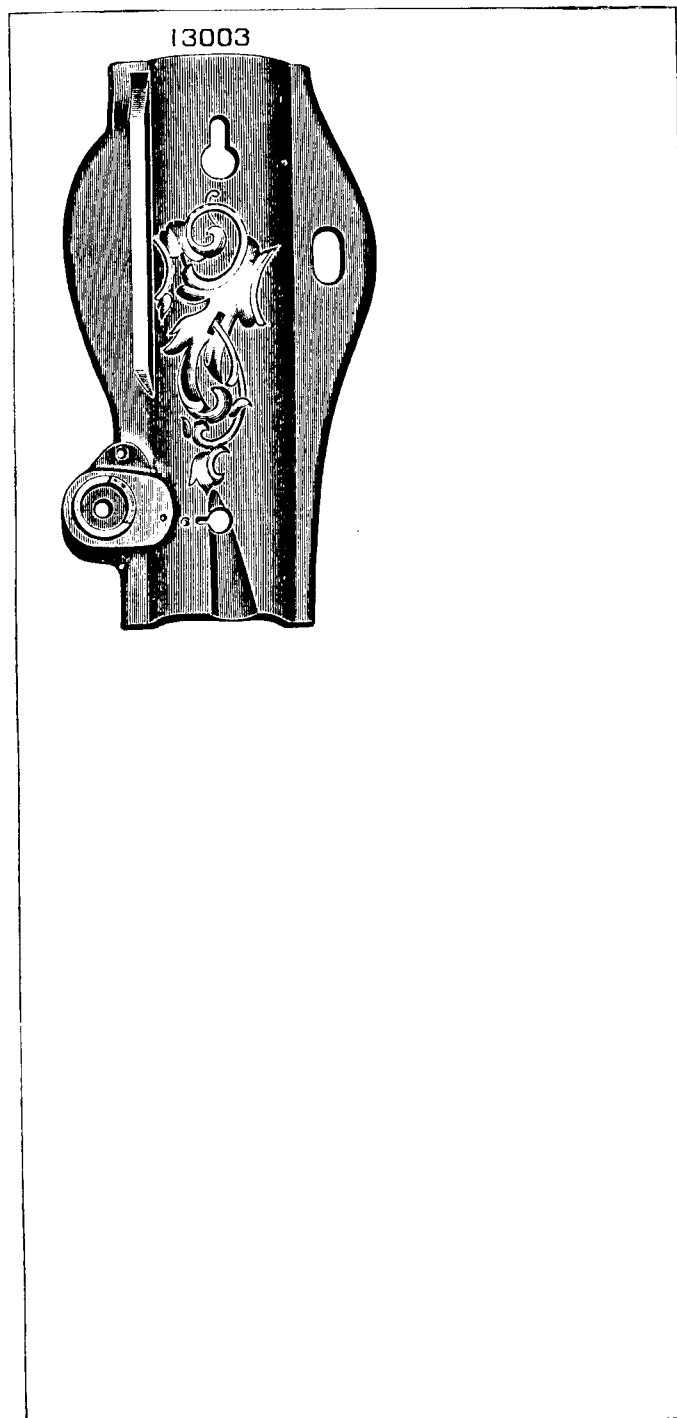


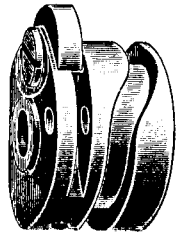
PLATE 719 ONE-HALF SIZE



From the library of: Diamond Needle Corp

PLATE 720—ONE-HALF SIZE

13043



13041

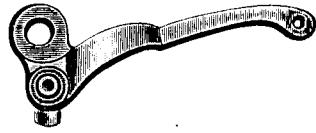
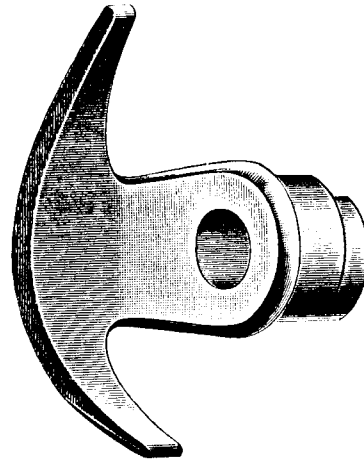


PLATE 721—FULL SIZE

13011



13015



PLATE 722 ONE-FOURTH SIZE

13036

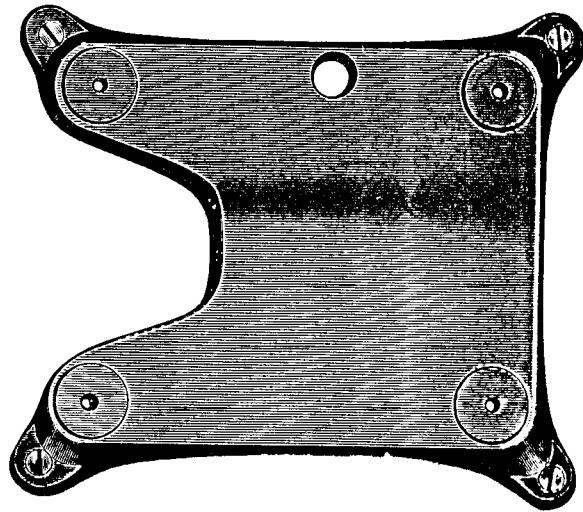


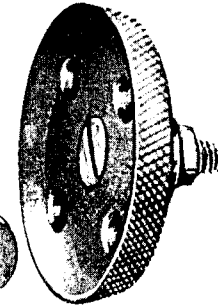
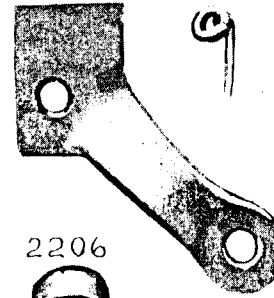
PLATE 723—FULL SIZE

3286

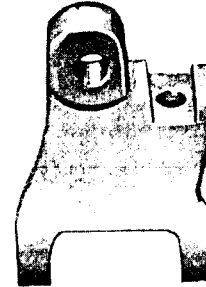
8152

6437

1875



2206



2052



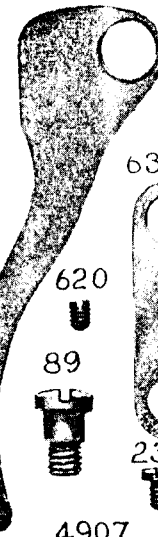
4810



5990



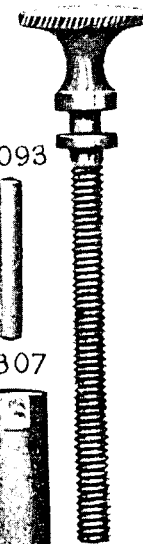
4855



2022



1014



6306



3093



620



89

237

6307



4907



13076



4959



PLATE 724—FULL SIZE

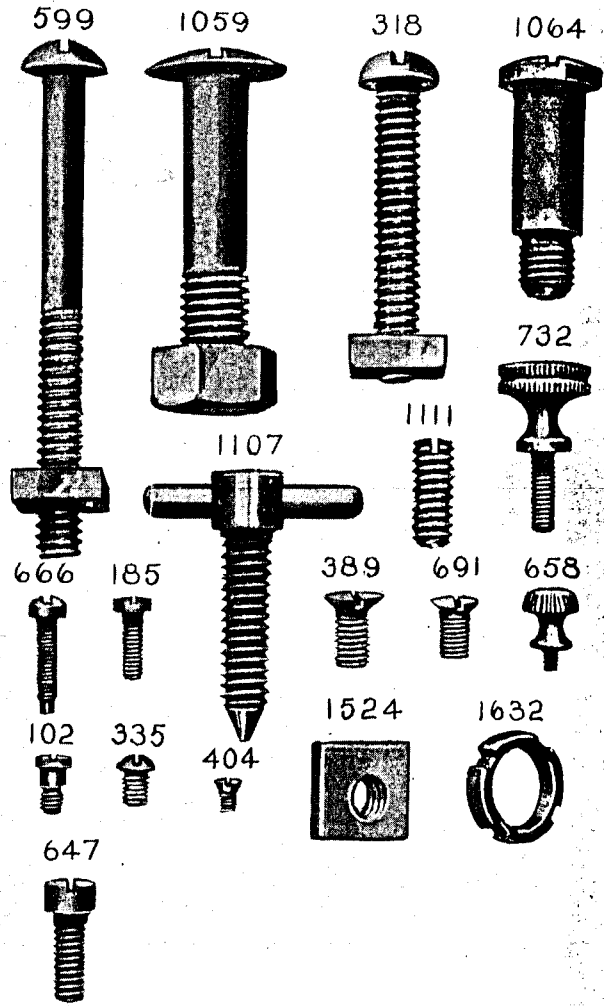


PLATE 725—FULL SIZE

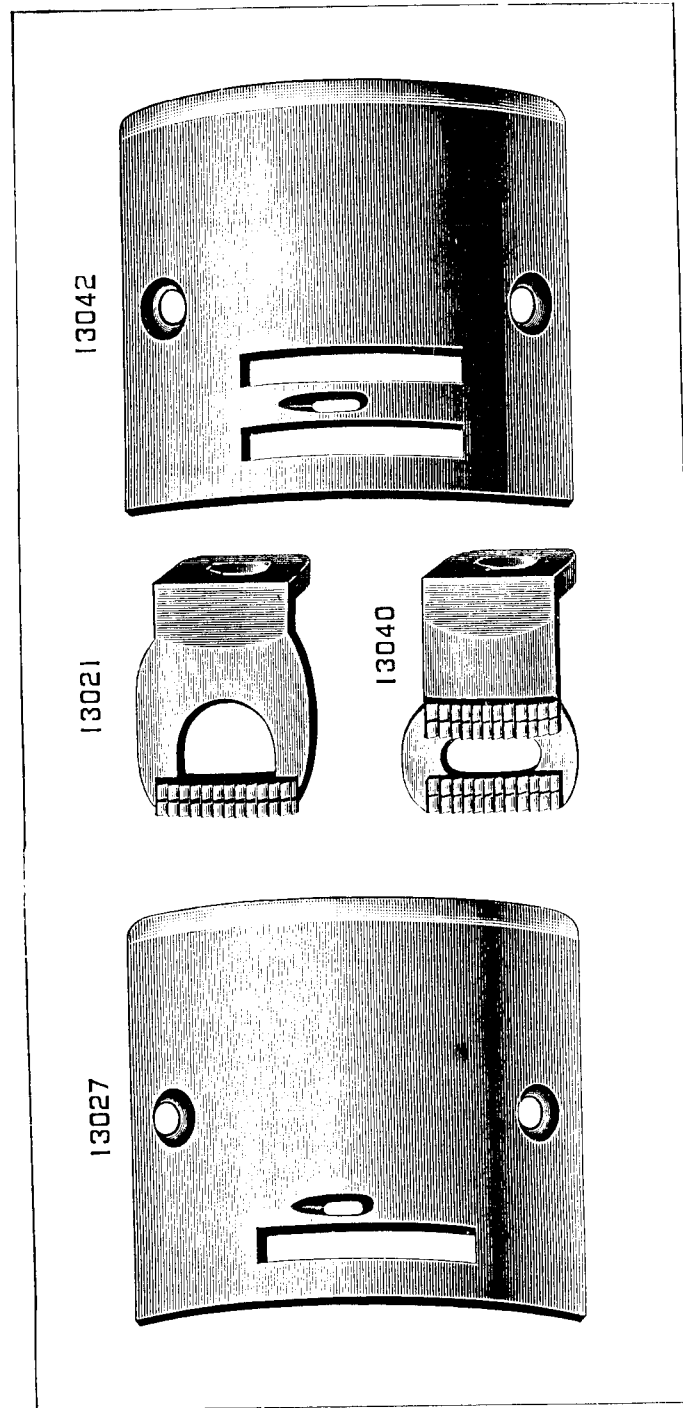


PLATE 726—FULL SIZE

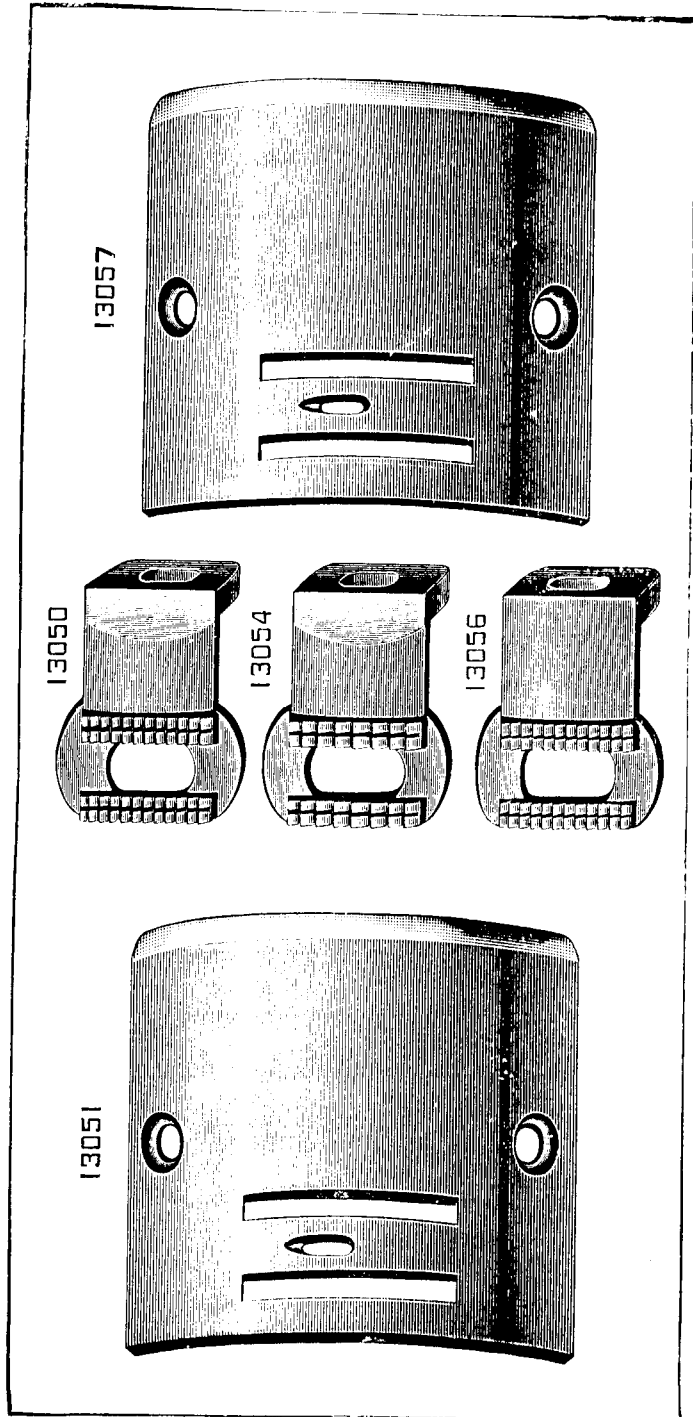
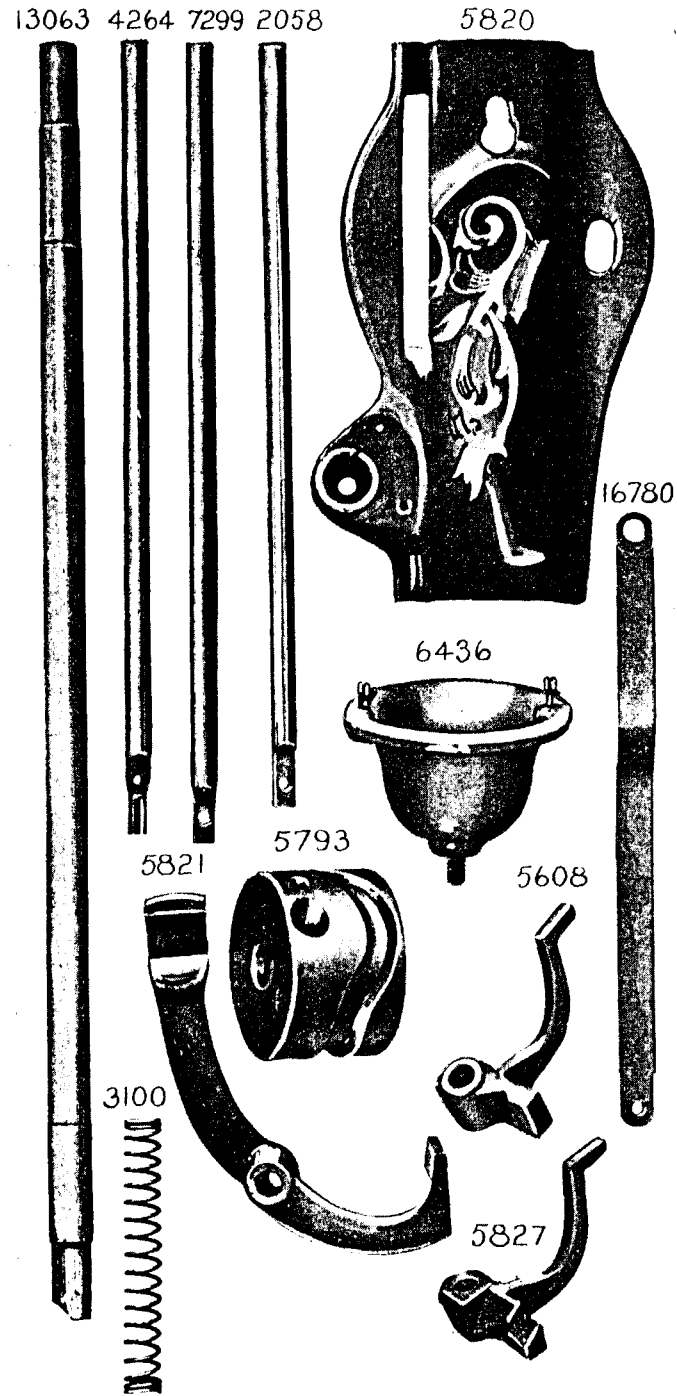


PLATE 727—ONE-HALF SIZE



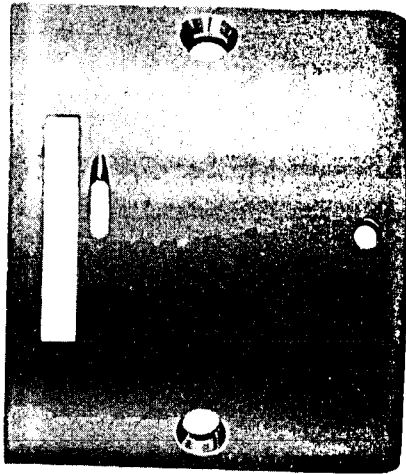
From the library of: Diamond Needle Corp

PLATE 728—FULL SIZE

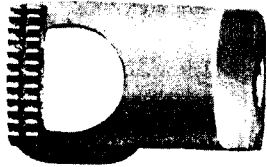
5971



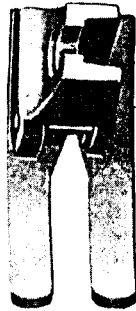
13059



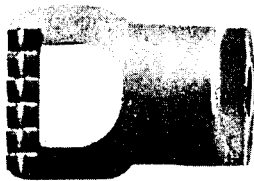
13058



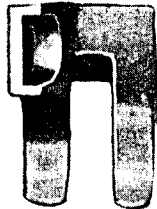
5921



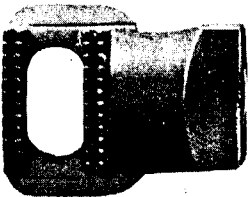
13061



5814



13060

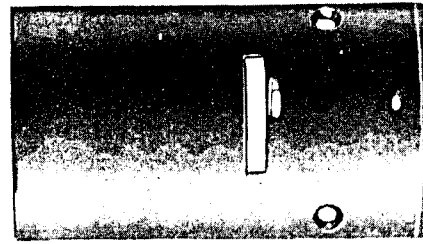


5816

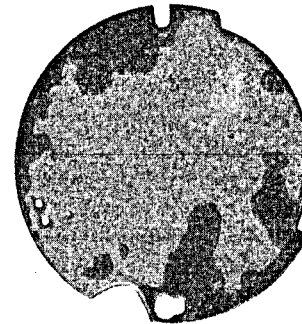


PLATE 729—ONE-HALF SIZE

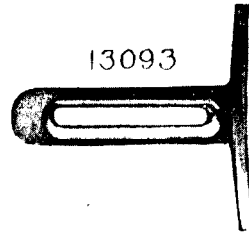
13096



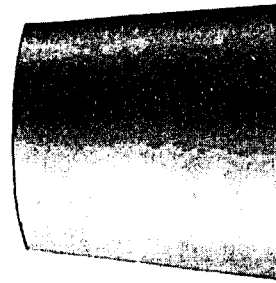
13094



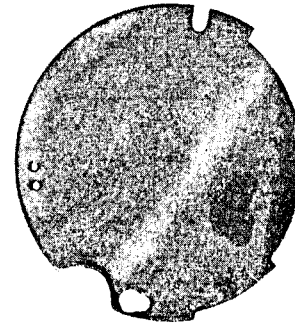
13093



13097



13087



13085

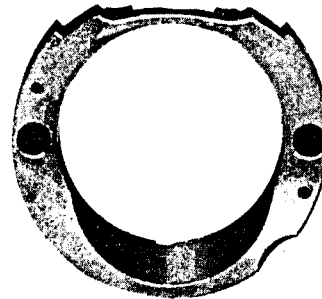


PLATE 730—FULL SIZE

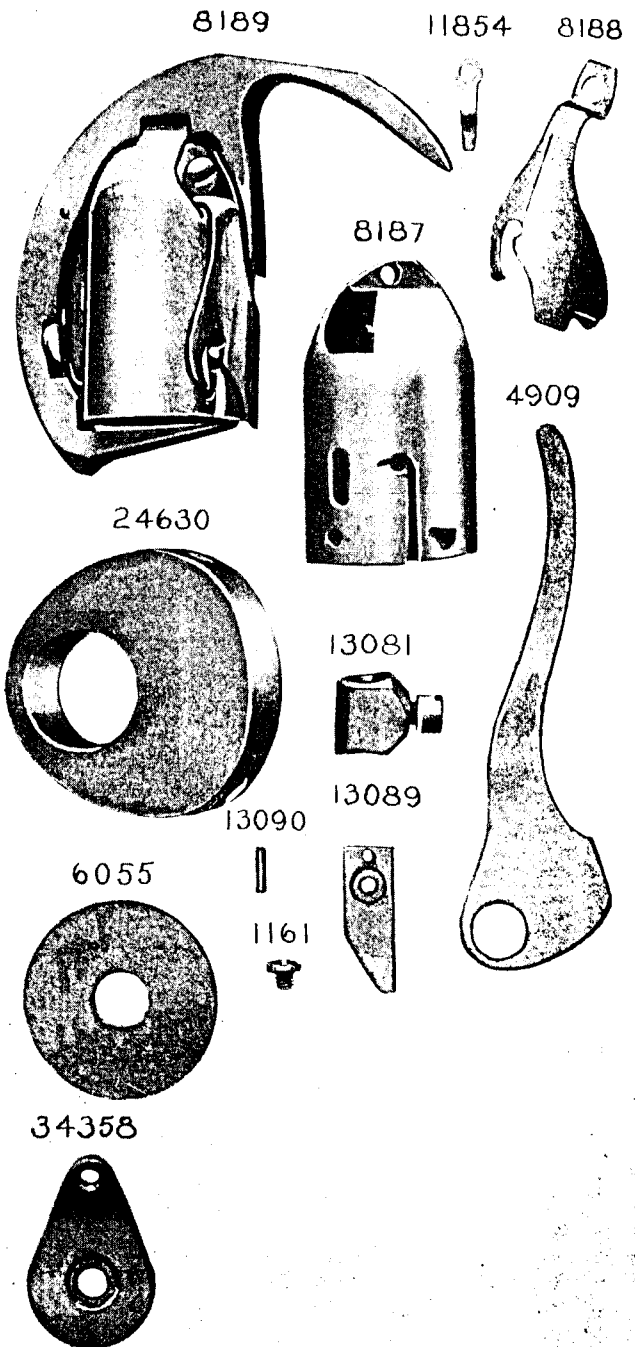


PLATE 3541—ONE-HALF SIZE

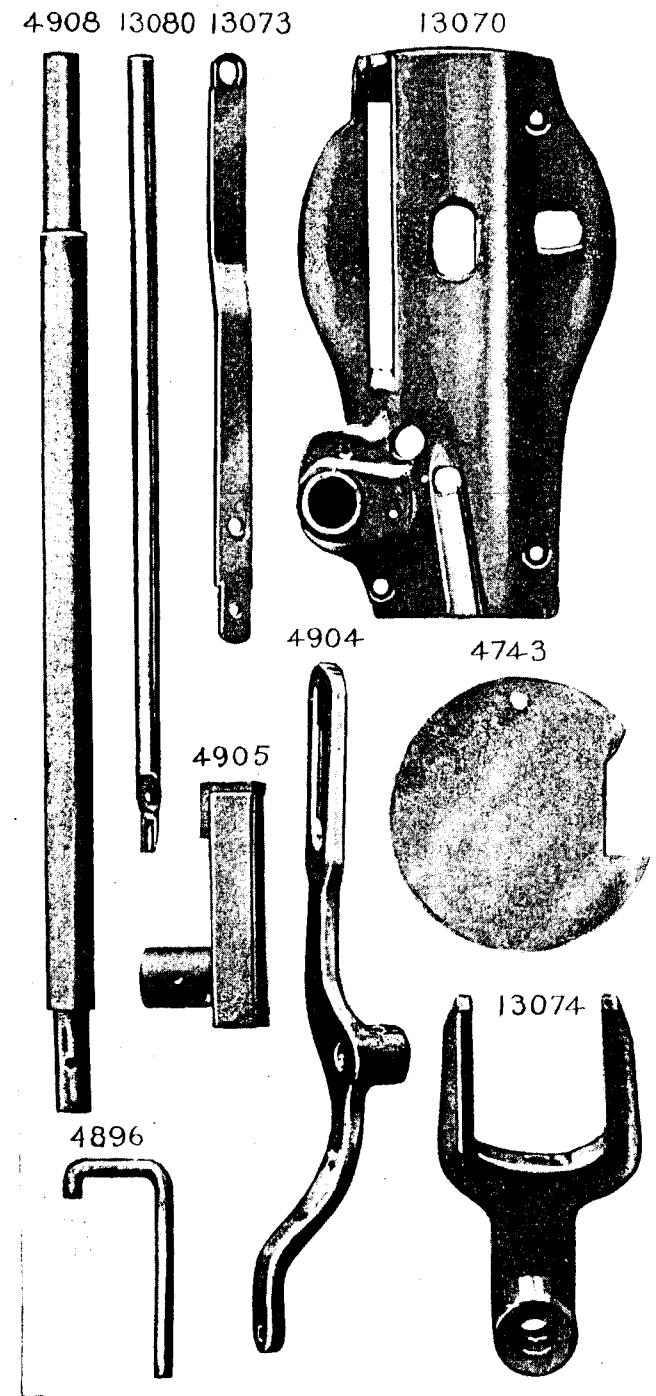
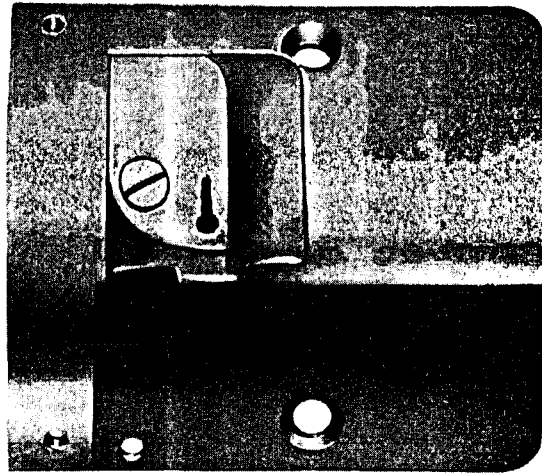


PLATE 3542—FULL SIZE

13084



13077



13079

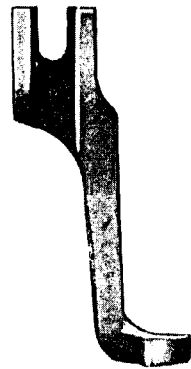
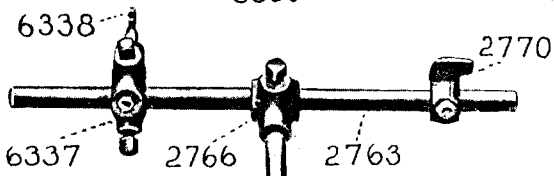
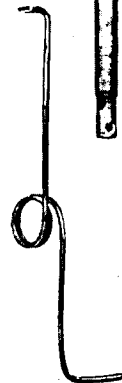


PLATE 3543—ONE-FOURTH SIZE

6179



16659



6178



6703

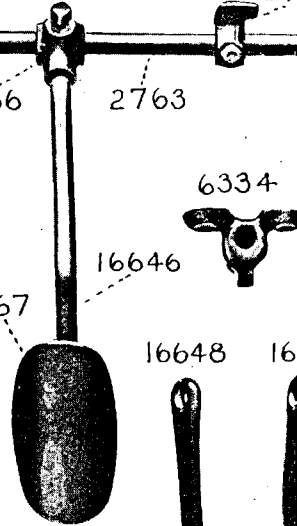


2767

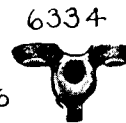
7170



6339



6343



6334

16646

16648



16641



6053

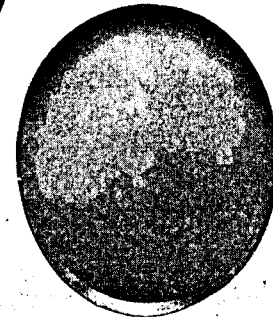
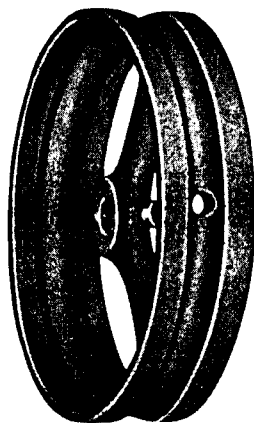


PLATE 3581—ONE-HALF SIZE

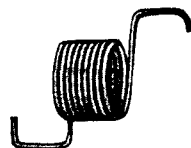
41443



41447



41442



41441



41440

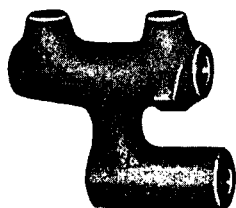
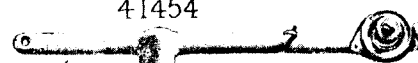


PLATE 3582—ONE-FOURTH SIZE

41454

60608



27560

41514



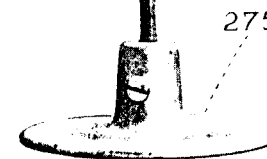
27555



41450



27557



From the library of: Diamond Needle Corp

PLATE 3583—FULL SIZE

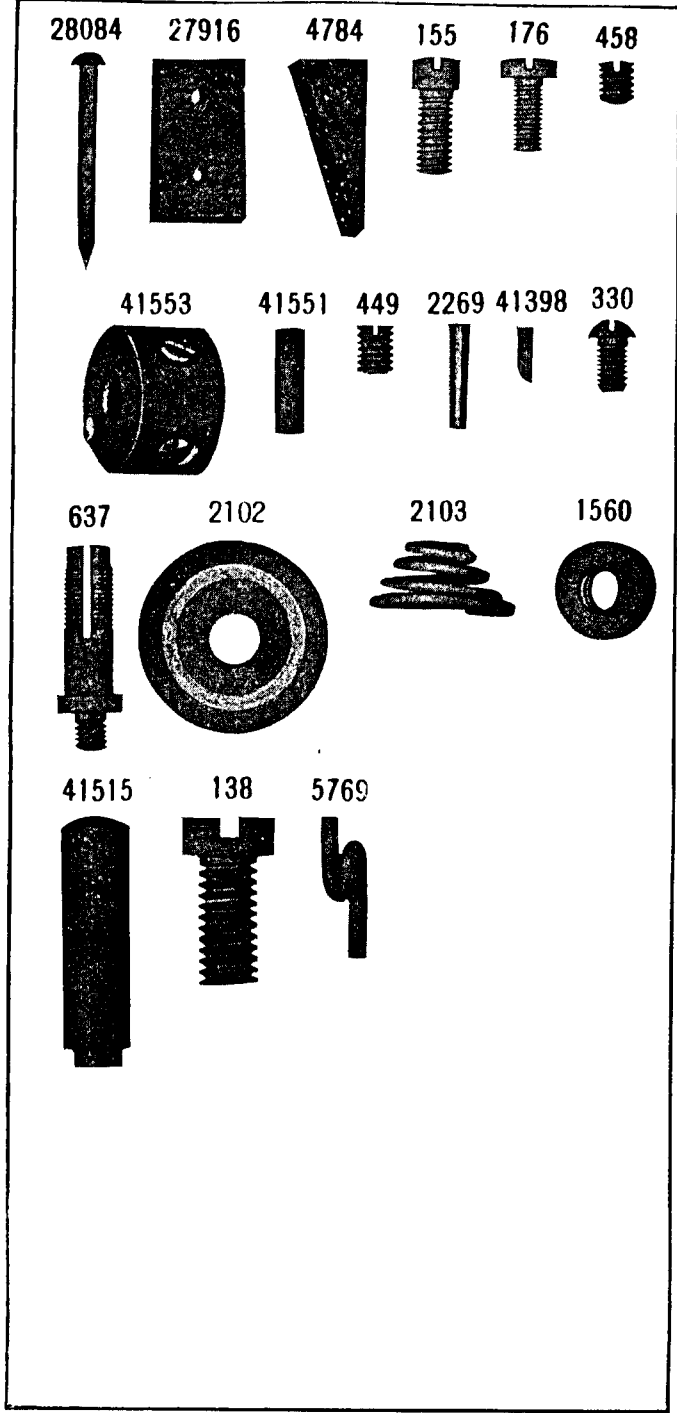
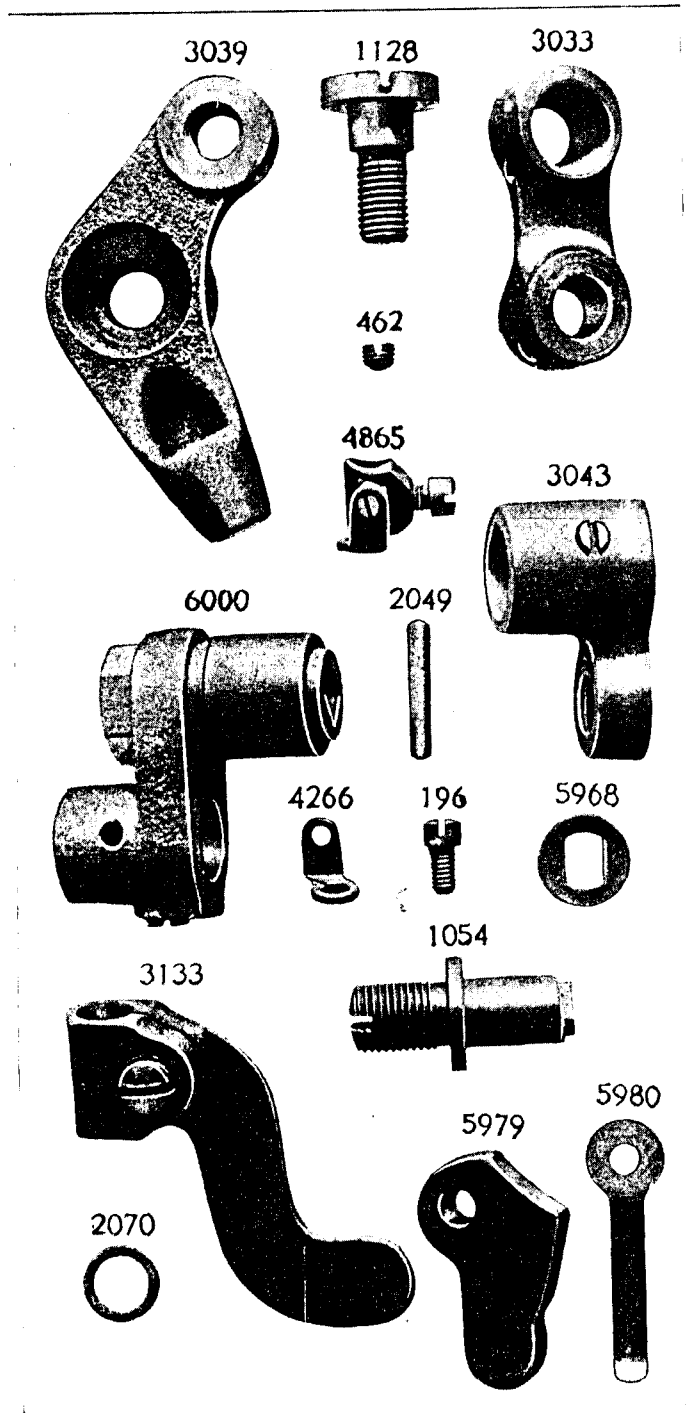


PLATE 3632—FULL SIZE



From the library of: Diamond Needle Corp

PLATE 3633—FULL SIZE

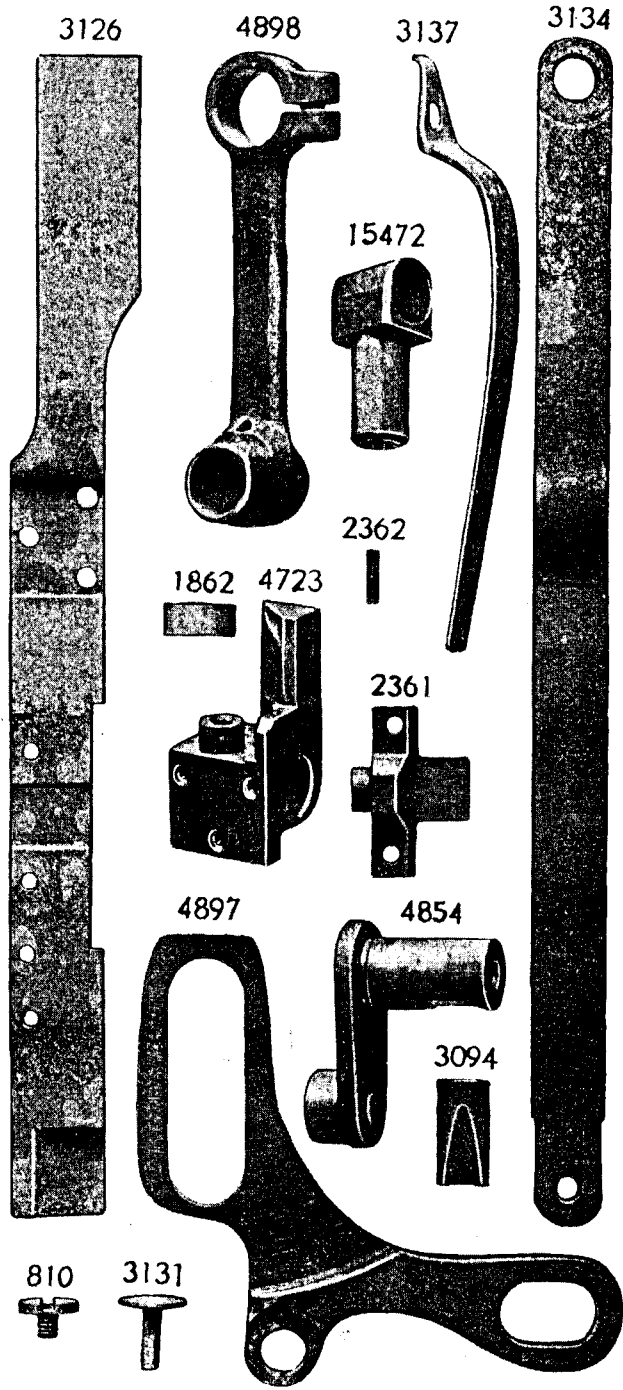
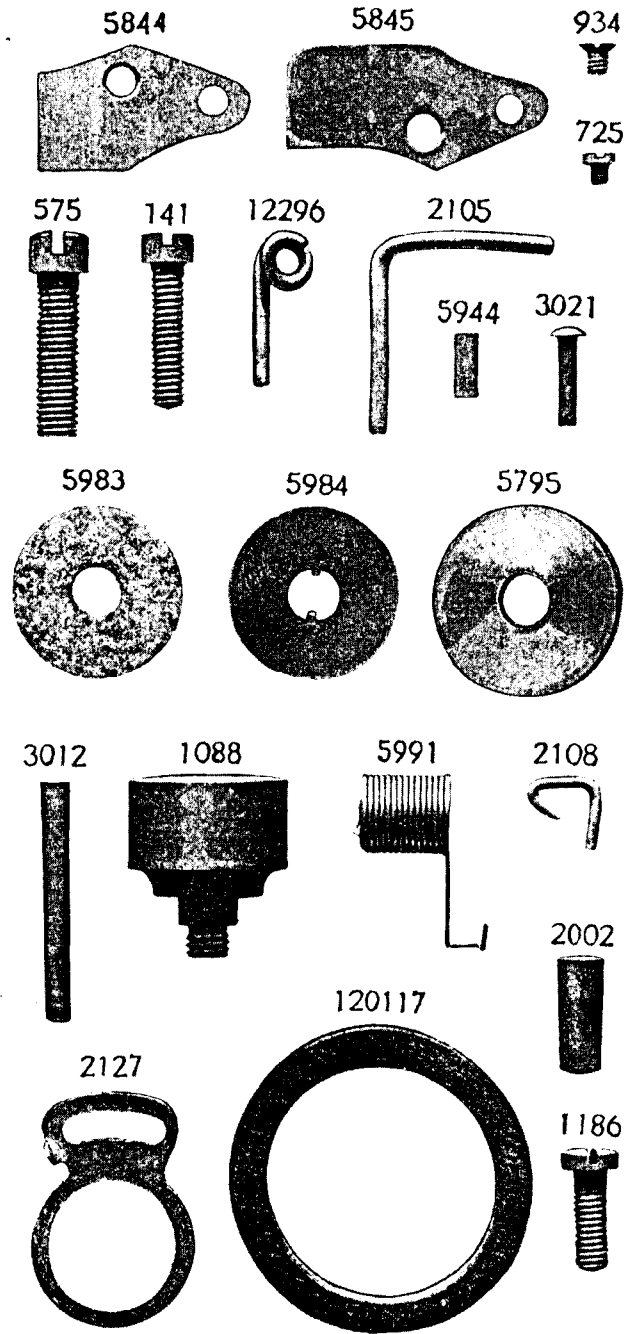


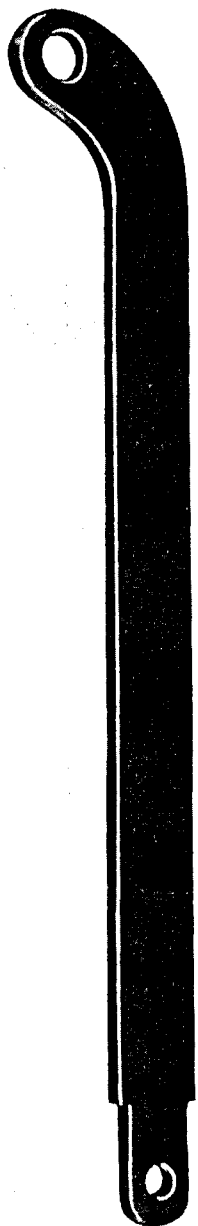
PLATE 3636—FULL SIZE



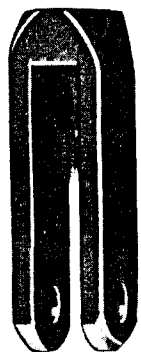
From the library of: Diamond Needle Corp

PLATE 3646—FULL SIZE

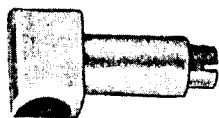
5885



5879



3147



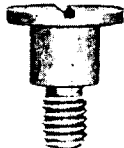
5878



1068



902



2653



5887

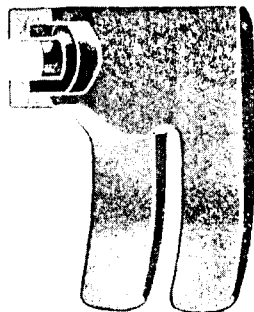
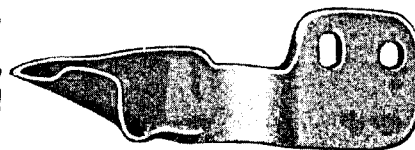
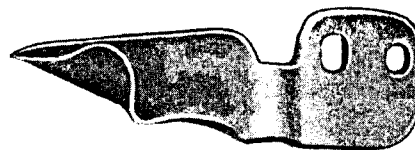


PLATE 5664—FULL SIZE

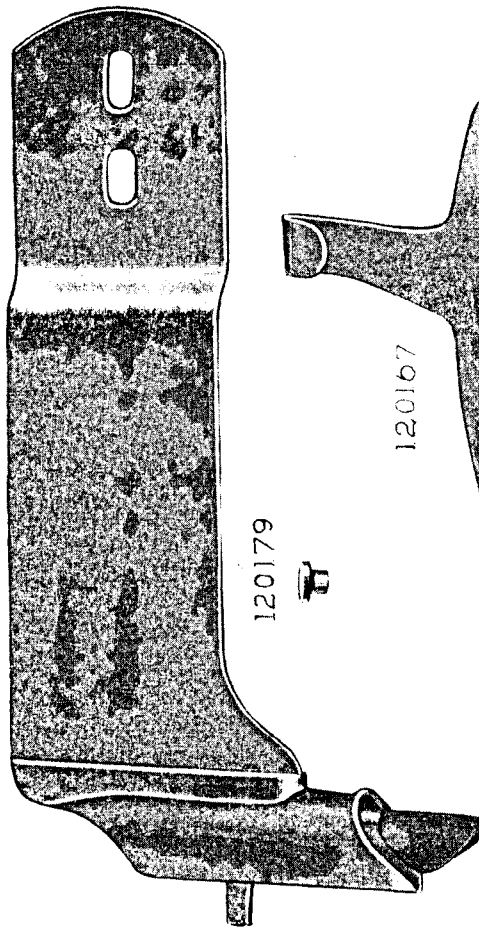
120169



120168



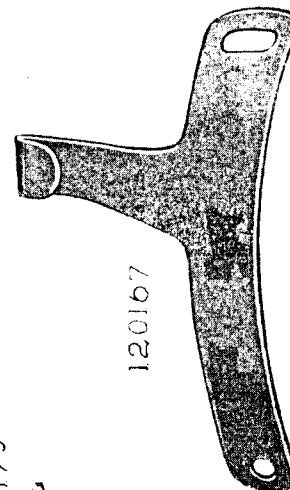
120178



120179



120167



From the library of: Diamond Needle Corp

PLATE 7800—ONE-HALF SIZE

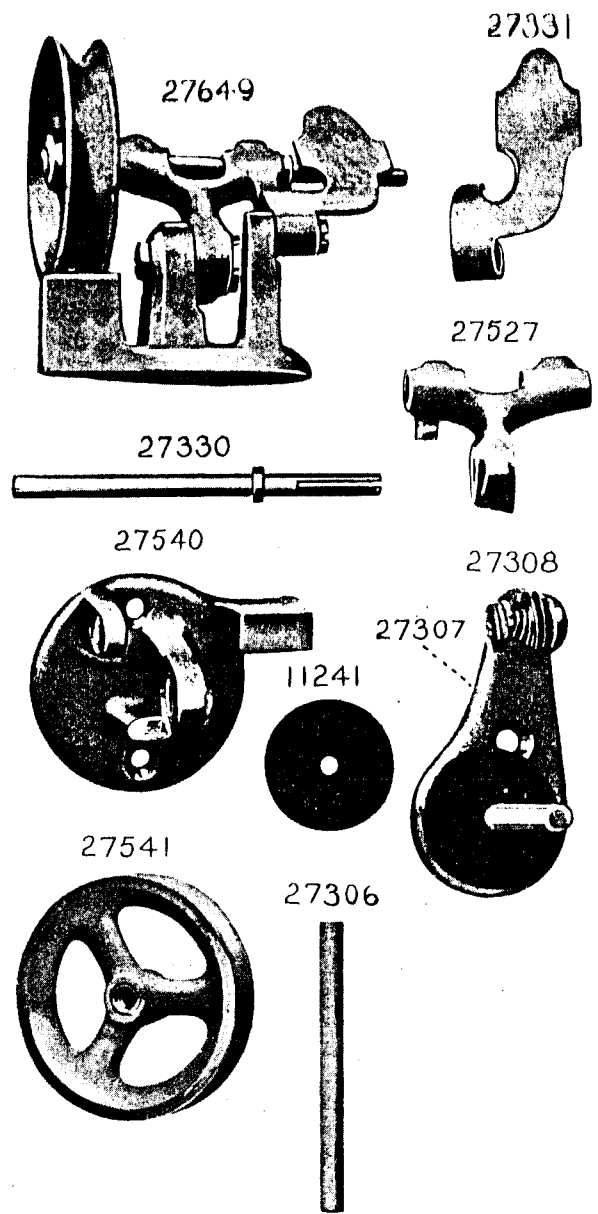
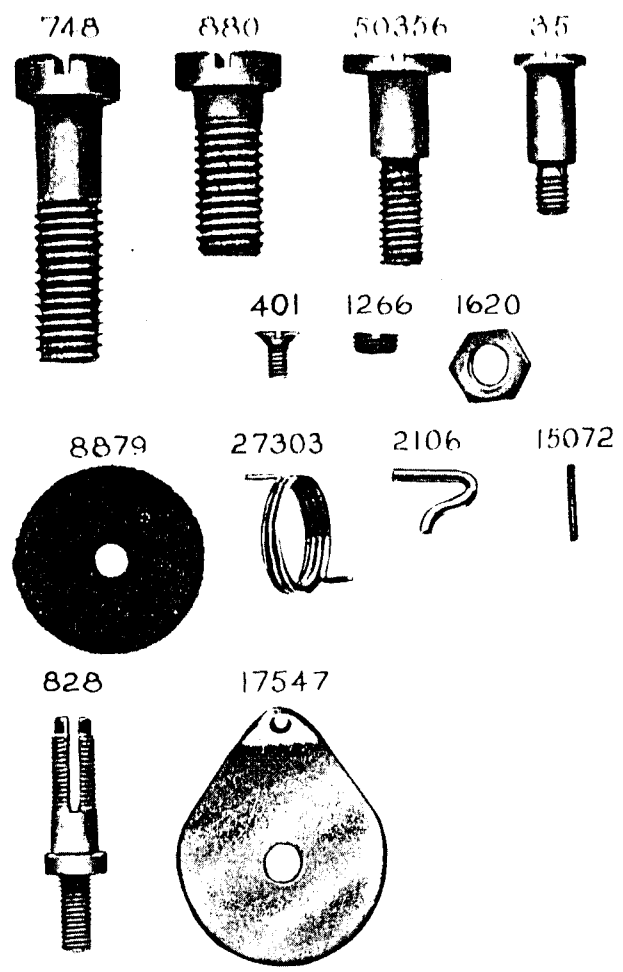


PLATE 7801—FULL SIZE



From the library of: Diamond Needle Corp

PLATE 7804—ONE-HALF SIZE

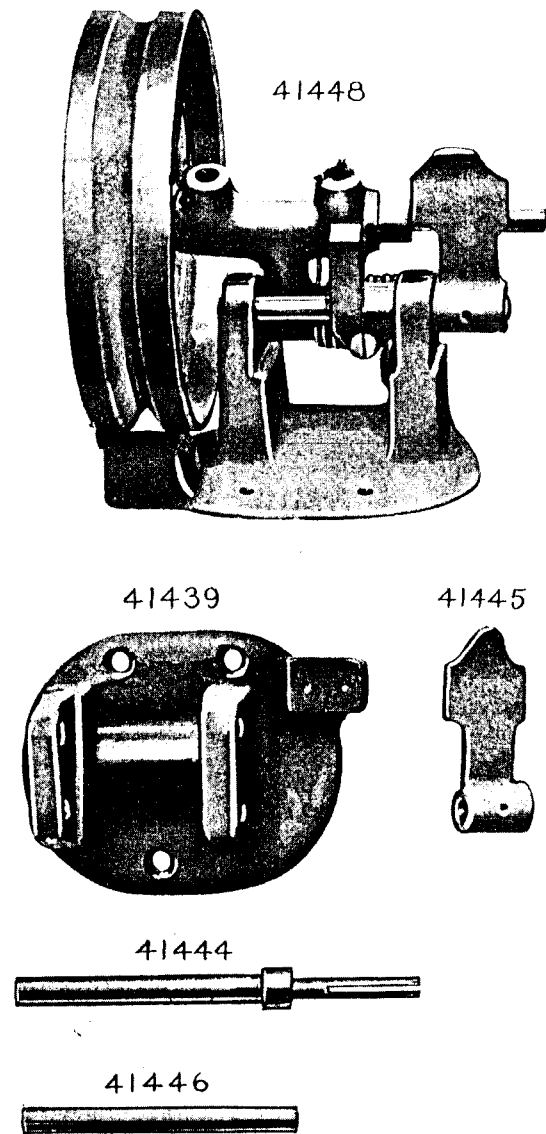


PLATE 7805—ONE-HALF SIZE

